











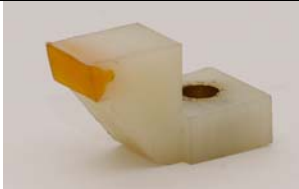

	GRIPPER PAD P-112013		GRIPPER PAD P-112014		GRIPPER PAD P-112016
	GRIPPER PAD P-112017		GRIPPER PAD P-112018		GRIPPER PAD P-112019
	GRIPPER PAD P-112029		GRIPPER PAD P-112030		GRIPPER PAD P-112010
	GRIPPER PAD P-112011		GRIPPER PAD P-112021		GRIPPER PAD P-112022

KOMORI**PRINTERS PARTS**
800-543-1117 201-935-9595
fax 800-392-4072 201-935-5333
www.ppsnj.com**GRIPPERS**

	GRIPPER P-112007		GRIPPER PAD P-112008		GRIPPER P-112009
	GRIPPER P-112023				DELIVERY GRIPPER P-112012

KOMORI**FORWARDING SUCKERS**

	FORWARDING SUCKER P-112003		FORWARDING SUCKER P-112004
	FORWARDING SUCKER P-112005		FORWARDING SUCKER P-112006

KOMORI

PRINTERS PARTS
 800-543-1117 201-935-9595
 fax 800-392-4072 201-935-5333
 www.ppsnj.com

**SHEET PLATES**

	SHEET PLATE P-112024		SHEET PLATE P-112025		SHEET PLATE P-112026
	SHEET PLATE P-112027		SHEET PLATE P-112028		

KOMORI**MISCELLANEOUS PRODUCTS**

	CAM FOLLOWER P-112000		BRUSH PAIR P-112001
	HICKEY WIPER P-112002		BRUSH P-112020









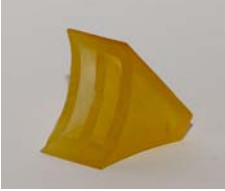

	GRIPPER PAD P-110000		GRIPPER PAD P-110001		GRIPPER PAD P-110002
	GRIPPER PAD P-110003		GRIPPER PAD P-110004		GRIPPER PAD P-110005
	GRIPPER PAD P-110006		GRIPPER PAD P-110007		GRIPPER PAD P-110008
	GRIPPER PAD P-110009		GRIPPER PAD P-110010		GRIPPER PAD P-110011
	GRIPPER PAD P-110012		GRIPPER PAD P-110013		GRIPPER PAD P-110014
	GRIPPER PAD P-110016		GRIPPER PAD P-110017		GRIPPER PAD P-110018
			GRIPPER PAD P-110019		

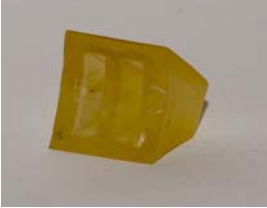

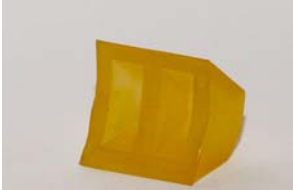
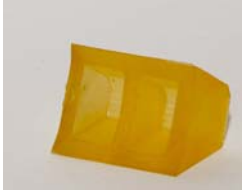

MANROLAND

PRINTERS PARTS
 800-543-1117 201-935-9595
 fax 800-392-4072 201-935-5333
 www.ppsnj.com

**GRIPPER PADS**

	GRIPPER PAD P-110040		GRIPPER PAD P-110041		GRIPPER PAD P-110042
	GRIPPER PAD P-110043		GRIPPER PAD P-110044		GRIPPER PAD P-110045
			GRIPPER PAD P-110046		
	GRIPPER PAD P-110047		GRIPPER PAD P-110048		GRIPPER PAD P-110049









MANROLAND**FORWARD SUCKERS**

	FORWARD SUCKER P-110021		FORWARD SUCKER P-110022		FORWARD SUCKER P-110023		FORWARD SUCKER P-110024
--	--	---	--	--	--	---	--

MANROLAND

PRINTERS PARTS
 800-543-1117 201-935-9595
 fax 800-392-4072 201-935-5333
 www.ppsnj.com

**INK DUCT END BLOCKS**

	INK DUCT END BLOCK P-110032		INK DUCT END BLOCK P-110033		INK DUCT END BLOCK P-110034		INK DUCT END BLOCK P-110035
	INK DUCT END BLOCK P-110036		INK DUCT END BLOCK P-110037		INK DUCT END BLOCK P-110038		INK DUCT END BLOCK P-110039

MANROLAND**CAM FOLLOWERS**

	CAM FOLLOWER P-110025		CAM FOLLOWER P-110026		CAM FOLLOWER P-110027
---	---	--	---	--	---

MANROLAND**CARRIER LINKS**

	CARRIER LINK P-8720		CARRIER LINK P-110052		CARRIER LINK P-110053
--	---------------------------------------	---	---	---	---



DELIVERY GRIPPERS

	<p>DELIVERY GRIPPER P-110028</p>		<p>DELIVERY GRIPPER P-110029</p>
	<p>DELIVERY GRIPPER P-110030</p>		<p>DELIVERY GRIPPER P-110031</p>



FEEDER WHEELS

	<p>FEEDER WHEEL P-110054</p>		<p>FEEDER WHEEL P-110055</p>		<p>FEEDER WHEEL P-110056</p>
	<p>FEEDER WHEEL P-110057</p>		<p>FEEDER WHEEL P-110058</p>		<p>FEEDER WHEEL P-110059</p>

MANROLAND

PRINTERS PARTS
800-543-1117 201-935-9595
fax 800-392-4072 201-935-5333
www.ppsnj.com



FEEDER BRUSHES

	FEEDER BRUSH P-110060		FEEDER BRUSH P-110061		FEEDER BRUSH P-110062
	FEEDER BRUSH P-110063		FEEDER BRUSH P-110064		FEEDER BRUSH P-110065

MANROLAND



SHEET SEPARATOR

	SHEET SEPARATOR P-110067		SHEET SEPARATOR P-110068		SHEET SEPARATOR P-110069
---	---	--	---	--	---

MANROLAND



MISCELLANEOUS PRODUCTS

	SHEET SLOW DOWN BELT P-110066		PUMP FILTER P-110070		PUMP FILTER P-110071
---	--	---	---------------------------------------	---	---------------------------------------