

EAST COAST GRAPHICS, INC.

PRINTERS PARTS STORE

SUPPLIES / EQUIPMENT / ACCESSORIES

YOUR ONE STOP SHOP FOR ALL YOUR PRESSROOM NEEDS

WE HAVE EXACTLY WHAT YOU NEED TO MAKE THE RIGHT IMPRESSION

2004 PRODUCT CATALOG FOR: PARTS / SUPPLIES / ACCESSORIES / EQUIPMENT

Addition Pens • Aerosols • Air Purifiers • Alignmate • Anti-Tracking Systems • Base-Line • Baum Folder • Big Foot Sucker Tubes • Blades - Art & Razor • Blankets • Blanket Bars • Blanket Fix • Chemicals • Plate Care • Clean -

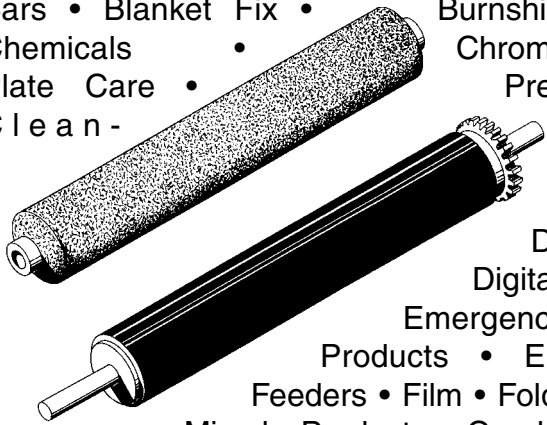

Burnshine Product • Business Card Slitters • Chrome Roller • Gum • Fountain Solution Press Wash • Roller & Blanket Care

up Sheets • Corner Rounder • Cotton Pads • Counters • Cutters • Knives • Sticks • Crestline • Dampening Covers • Deletion Pens • Digital Duplicator Supplies • Drills, Bits

Emergency Repair Kits • Emerald 2000 Products • Envelope Backstops • Envelope

Feeders • Film • Folders • Folder Parts • Gloves • Gold • Miracle Products • Graphline Plates • Handwaxer and Wax

• Hand Cleaner • Handi-Pads & Wipes • H.S. Boyd • Ink Knives • Ionix • Static Eliminator • Joggers • Knives, Blades & Sets • Lamps for Presses • Laser Direct Plates • Linen Testers • Loupes • Litho Perf • Litho Tape • Masking Sheets • MBM Products • Micrometers • Non-Repro Pens • Numbering Machines • Oil •

O p a q u e
P e n s •

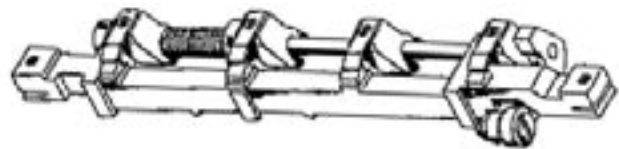
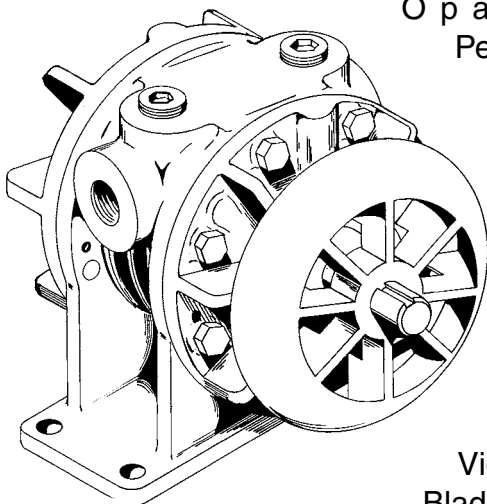
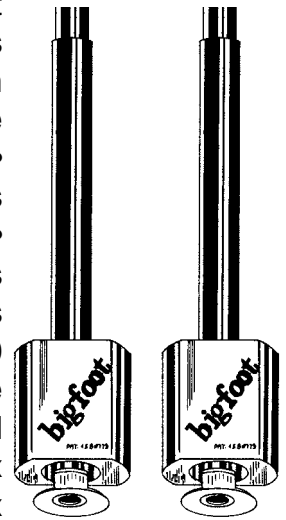

Padding Press • Paper Cutters • Paper Drill • Pens • Perf Rules • Plates • Plate Punch • Plunger Cans • Powder Spray Units • Press & Pump Oil • Press Washers • Prodeco Products • Proportion Scales • Red Runner Sleeves • Rollers & Kits • Rulers • Scales • Score II • Shop Towels • Spinks Inks • Staplers & Staples • Thickness Gauge • Tools • Varn Products • Video Repair Tapes • WD-40 • Wash-Up Attachments & Blades • Waxers & Wax • Webril Wipes • Wizer Products

EAST COAST GRAPHICS, INC. - PRINTERS PARTS STORE

82 HERMAN STREET EAST RUTHERFORD, NJ 07073

800-543-1117 / 201-935-9595 Fax: 800-392-4072 / 201-935-5333

web site: www.ppsnj.com e-mail: info@ppsnj.com

STORE AND PICK-UP COUNTER HOURS: Mon - Fri 8:30 a.m.- 5:00 p.m.

LOCATED MINUTES FROM NYC, NJ TURNPIKE & GARDEN STATE PARKWAY

CALL FOR EASY DIRECTIONS OR ONLINE WWW.PPSNJ.COM/DIRECTIONS.HTML

SPECIAL DISCOUNTS FOR EXPORT ORDERS - WE SHIP WORLDWIDE

DEALER, REPAIRMEN & SERVICE TECHNICIAN DISCOUNTS OFFERED

HIGH VOLUME END USERS - CALL US FOR SPECIAL DISCOUNTS

IMMEDIATE DELIVERY - NO MINIMUM ORDER

SAVE COD CHARGES, WE ACCEPT: VISA - MASTERCARD - AMERICAN EXPRESS - CHECKS-BY-FAX - WWW.PAYPAL.COM
WHEN YOU NEED TECHNICAL SALESPeOPLE, WE'RE ONLY A PHONE CALL AWAY.

This booklet has only a sample of our total inventory. If you don't see it, please call us.

****** PRICES SUBJECT TO CHANGE WITHOUT NOTICE ******

Index of Products:		D		K		Prodeco Products	
A		Dampening Covers	9	Knives, blades & sets	13	Proportion Scales	15
ABDick, parts for	1,3,4,5	DAVIDSON parts for	1,3,4,5	KOMPAC Units & Parts	6	R	
Addition pens	14	Deletion pens	14	L		Red Runner Sleeves	9
Aerosols	10	Digital Duplicator supplies	29	Lamps for presses	1	Rollers & Kits	3
Air Purifiers	23	Drills, bits, supplies	24	Laser Direct Plates	17	RYOBI, parts for	1,3,4
Alignmate	15	Duroweave Products	9	Linen Testers/Loupes	15	Rulers	14
Anti-Tracking Systems	32	E				S	
B		Emergency Repair Kits	4	Litho Perf, Score, Slit	27	Scales	15
Base-Line	12,13	Emerald 2000 Products	10	Litho Tape, red & clear	13	Score II	25
Baum Folder	9	Envelope Backstops	28	M		Shop Towels	5
Big Foot Sucker Tubes	8	Envelope Feeders	30	Masking Sheets	13	Spinks Ink	27
Blades-art & razor	13	F		MBM Products	9,20,22	Staplers & Staples	25
Blankets	11	Film	18	Micrometers	16	T	
Blanket Bars	11	Folders	23	MULTILITH, parts for	1,3,4,5	T-51, parts for	1,3,4,5,32
Blanket Fix	11	Folder parts	9	N		Thickness Gauge	16
Burnshine Product	19	G		Non-repro pens	14	TOKO, parts for	1,3,4,5
Business Card Slitter	28	Gloves	12	Numbering Machines	28	Tools	5
C		Gold Miracle Products	19	O		V	
Chemicals	18,19,20	Graphline-Plates	17	1 Step Chain Saver	10	Varn Products	6,10,19,20
Chrome roller/cyl. care	18	H		Oil, machine & pump	5,10	Video Repair Tapes	5
Gum	19	HAMADA, parts for	1,3,4	Opaque Pens	14	W	
Fountain solution	18,19	Handwaxer & wax	13	P		WD-40	10
Plate care	19	Hand Cleaner	19	Padding Press,Supplies	22	Wash-up Attachments	11
Press wash	20	Handi-Pads & Wipes	12	Paper Cutters,Supplies	21	Waxers & Wax	13
Roller & blanket care	19,20	HEIDELBERG parts for	2,3,4	Paper Drill & Supplies	24	Webril Wipes	12
CHIEF, parts for	1,3,4	H.S.Boyd	10	Pens:addition & deletion	14	Wizer	22,24,25,26,28
Clean-up Sheets	12	I		Perf Rules	10		
Copier Toner	29	Ink Knives	27	Plates, metal & laser	17		
Corner Rounder	27	Ionix Static Eliminator	8	Plate Punch	8,28		
Cotton Pads	12	ITEK, parts for	1,3,4	Plunger Cans	12		
Counters	12	J		Powder Spray Units	26		
Cutters, Knives, Sticks	21	Joggers	23	Press Parts, misc.	1,2,3,4,5		
Crestline	7			Press & Pump Oil	5		
				Press Washers	11		

Common and General Parts for AB Dick, Ryobi / Itek, Multilith, Hamada, Heidelberg, Chief, Davidson, Toko and Townsend T-51. Just a small sample of what we have.

OIL-LESS VACUUM PUMPS

Complete with jars & piping for AB Dick, Multi, Chief, Davidson

- P-1645** \$500.00
- P-1935** for ABDick 9880/385 NS \$1000.00
- P-1645-RYOBI** \$599.00

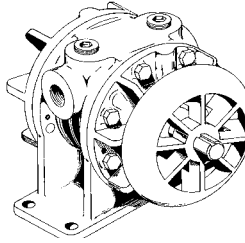

VACUUM PUMP REPAIR KITS

All the necessary parts to rebuild your old pump (excluding bearings):

FOR NEW STYLE OIL-LESS PUMPS

- P-30314** \$130.00
- P-5860** Flushing Solution for P-30314 \$ 84.90

FOR OLD STYLE PUMPS USING OIL

- P-1182** ABDick 350,360,375,9800 \$ 99.80
- P-1930** ABDick 385 AirVac Pumps \$340.00
- P-1961** All Multiliths \$119.90
- P-1960** All Chiefs & Davidsons \$119.90

WATER BOTTLES

- P-1915** AB Dick \$18.75
- P-1918** Hamada \$22.00
- P-1912-PPS** Multi NS \$20.00
- P-1911** Multi OS, Chief OS \$18.75
- P-1914-PPS** Chief NS \$18.00
- P-1913** Davidson \$18.75
- P-1916-PPS** T-51 all units \$20.00
- P-1917-PPS** T-51 w/collar \$24.00
- R-5290-53-250-2** Ryobi 3" cap only \$69.25
- R-5300-53-250** Ryobi 1-3/4" cap only \$52.95
- V-92760** Kompac Cap \$14.55
- V-92771** Kompac Bottle \$ 7.75
- V-92780** Kompac Cap LP \$15.45
- V-92777** Kompac Bottle LP \$20.90

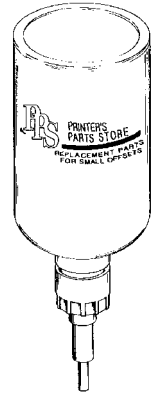

GRIPPER BAR ASSEMBLIES

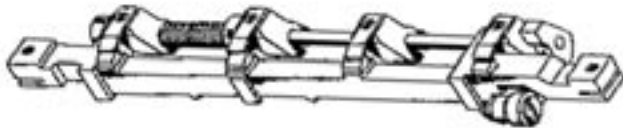

- P-360990** ABDick 350,360 \$240.00
- P-980990** ABDick 9800 NS \$240.00
- P-370990** ABDick 375/9800 OS \$219.60
- P-270990** Ryobi 2700/2800 \$439.90
- P-320990** Ryobi 3200/3302 \$399.90
- P-120990** Multi 1250 - AM Chain \$340.00
- P-130990** Multi 1360/1650 \$350.00
- P-180990** Multi 1850 \$490.00
- P-150990** Chief 15/17/215/217 \$264.00
- P-700990** Davidson 600/700 \$799.80
- D-88-2832-12** Davidson 701/702P \$799.80
- D-88-2832-14** Davidson 500 \$719.80
- D-88-2832-15** Davidson 501/502P \$719.80

Discounts in sets of 3. Please call if you do not see your press listed. All parts available separately. Gripper chains, too.

DUPLICATOR LAMPS

- P-1956** \$64.55
- P-1956-R** \$81.90

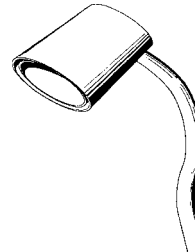

WASH-UP BOTTLE

- P-1929** \$11.00

Polyethylene bottle & tube. Tip dispenses uniform stream and extends to bottom of 1 qt. bottle.



ALL T-51 PARTS AVAILABLE

- T-1802-OEM** Worm \$29.20
- T-4804-OEM** Dog new style \$30.00
- T-1804** Dog old style \$27.00
- T-1132** T-Wrench \$24.60



SUCKER FEET FOR:

AB DICK:

- P-1555-66** Standard \$.35
- P-1555-L** Long Wear \$.35
- P-5219** Xtra Heavy \$1.10
- P-1552** 3/4" Flat \$.35
- P-1554** 1/2" Flat \$.35

RYOBI:

- P-5208** Standard \$.90

DAVIDSON:

- P-5204** Standard \$.95

HAMADA:

- P-5205** Heavy - Tan \$1.35
- P-5206** Light - Green \$1.35
- P-5207** Black Boot \$2.60

CHIEF:

- P-5201** Square \$8.00

TOKO:

- P-5203** Standard \$2.80



SHEET SEPARATORS:

RYOBI:

- P-27114** Brass \$1.00
- P-27117** Copper \$1.00

HAMADA:

- P-12114** All models \$0.45

MULTI:

- P-12114** Standard \$0.45
- P-13114** 1330/1360 \$1.30

CHIEF:

- P-15114** 15/17 \$.45
- P-52114** X-Series \$.95

DAVIDSON:

- P-52114** New Styles \$.95
- P-50114** Old Styles \$.45



DOLLY BOARDS

Reduce & Stop Offsetting. Call for pricing.



ATTENTION HEIDELBERG® USERS: We now carry replacement parts, rollers and supplies.
Check out our **LOW PRICES.** High volume, dealer & repairmen inquiries welcome. Call for special pricing.

CYLINDER JACKETS Made from High Grade Stainless Steel with the same specs as the O.E.M.



P-30850 WINDMILL 10x15	\$ 75.00	P-30856 KORS	\$151.80
P-30858 WINDMILL 13x18	\$102.50	P-30857 KORA	\$110.90
P-30851 GTO 46	\$50.00	P-30859 KOR	\$199.90
P-30852 GTO 52	\$74.00		
P-30853 M-Series	\$99.90	S-Series coming soon	
P-30854 KORD 62	\$119.80		
P-30855 KORD 64	\$129.00		

STAR RODS ASSEMBLY-brush wheels not included:

HE-463170	GTO 46	\$23.90
HE-523170	GTO 52	\$21.90
HE-M03170	M-Series	\$64.90
HE-SR3170	SORZ	\$87.90
HE-SD3170	SORDZ	\$82.90
HE-SK3170	SORKZ	\$87.90
HE-SM3170	Speedmaster 72	\$87.90
HE-SS3170	Speedmaster 102/SORSZ	\$92.50
HE-K0RD3170-62	KORD 62	\$77.90
HE-K0RD3170-64	KORD 64	\$94.00



TRACK PREVENTION BRUSH WHEELS FOR GTO, K/M SERIES:

P-30842	Brushwheel	\$12.90
----------------	------------	---------

VARIABLE SPEED PULLEY AND BELTS FOR K-SERIES

P-4291	Pulley	\$1598.00
P-3885	Belt (50hz-1800 mm)	\$171.00
P-3889	Belt (60hz-1900 mm)	\$240.00

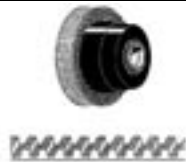

GRIPPER BAR ASSEMBLY FOR:

HE-WI0990-15	Windmill 10 x 15	\$540.00
HE-WI0990-18	Windmill 13 x 18	\$599.90
HE-T00990	Tok	\$699.90
HE-K0RS0990	Kors	\$1750.00
HE-K0R0990	Kor,Kora,Kord 62	\$1200.00
HE-K0RD0990	Kord 64	\$1330.00
HE-460990	GTO 46	\$949.90
HE-520990	GTO 52	\$999.90
HE-460990QM	Quickmaster	\$498.90

GRIPPER CHAINS:

HE-521100	GTO46/52	\$219.90
HE-461100QM	QM46	\$210.00
HE-461100DI	QM-DI	\$480.00

INK FOUNTAIN BLADES



HE-WI095-18	Windmill	\$447.90	HE-S0RZ095	Sorsz	\$599.90
HE-WI095-15	Windmill	\$277.90	HE-T0095	Tok/Tom	\$280.00
HE-46095	GTO 46	\$450.00	HE-M0095	M-Series	\$443.90
HE-52095	GTO 52	\$334.90	HE-S0RM095	Sorm/SM	\$979.90
HE-K0RD095	Kord 64	\$350.00	HE-S0RSZ095	Sorsz	\$974.90
HE-K0RS095	Kors	\$328.50	HE-S0RKZ095	Sorkz	\$593.00

TEFLON SEALS FOR KOMPAC

P-30713	TOK, TOM	\$18.90
P-30712	Kompac III	\$19.90

Note: a set consists of 1 ea.- L.H. & R. H.

SUCKER BAR SLIDES



P-30754	Windmill (red)	\$11.00	P-30752	GTO46165MM	\$10.50
P-30755	Windmill (yellow)	\$11.00	P-30753	GTO 4663MM	\$10.00
P-30756	Windmill (pink)	\$15.95			

FEEDER BRUSH WHEELS

HE-SR420	K, M, S, Speedmaster	\$49.90
HE-SR500	K, M, S, Speedmaster for cardboard stock - black brush	\$18.50



SUCKER FEET

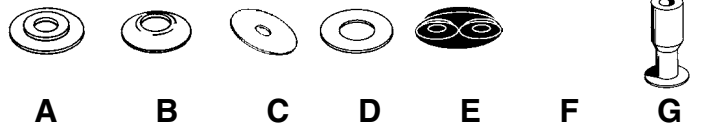

A) P-5222	GTO	.65
B) P-5210	Heidelberg/Kluge - (7/8" OD)	1.10
B) P-7556	K-Series - (1 1/16" OD)	.95
C) P-5223	Heidelberg - (5/32" ID x 1" OD)	.45
C) P-7566	Windmill - (5/32" ID x 7/8" ID)	.35
C) P-5234	Windmill - (1/8" ID x 29/32" OD)	.35
D) P-5236	SOR - (1-1/4" OD)	.65
D) P-5240	MO/SOR - (1-3/16" OD)	.65
D) P-5243	MO/SOR - (1-1/2" OD)	.65
E) P-5218	K-Series/SORZ - For tissue paper	4.95
F) P-7558	Quickmaster 46 / 46DI	.65
G) P-5215	TOM / TOK	1.70

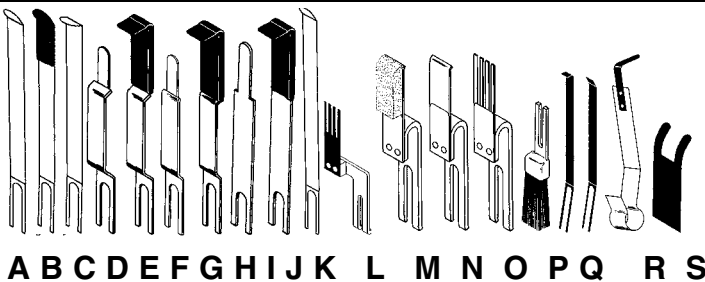

SHEET SEPARATORS:

(A) HE-K0114	KORD (45°)	\$7.25	(K) HE-52107	GTO 52(stream feed Non-Op side)	\$53.40
(B) HE-K0420	KORD (45°w/pad)	\$10.90	(L) HE-S0117	MS Series	\$24.90
(C) HE-K0117	KORD (90°)	\$7.25	(M) HE-S0114	MS Series	\$24.90
(D) HE-KS117	K-Series	\$11.90	(N) HE-S0106	MS Series	\$31.00
(E) HE-KS114	K-Series w/hood	\$9.90	(O) HE-S0107	MS Series	\$29.90
(F) HE-46117	GTO 46	\$5.60	(P) HE-SB117	SB Series (90°)	\$ 9.50
(G) HE-46114	GTO 46 w/hood	\$6.00	(Q) HE-SB114	SB Series (45°)	\$ 9.50
(H) HE-52117	GTO 52	\$9.90	(R) HE-WI114	Windmill	\$ 10.00
(I) HE-52118	GTO 52 w/hood	\$9.90	(S) HE-WI117	Windmill	\$ 9.50
(J) HE-52114	GTO 52 (45°)	\$3.10			
(K) HE-52106	GTO 52(stream feed operators side)	\$53.40			

ROLLERS: Premium quality rollers. **Syn-Tac®** Roller kits at reduced prices for AB Dick, Ryobi, Itek, Multilith, Hamada, Heidelberg, Chief, Davidson, Toko, T-51, Didde-Glaser Halm Jet, Kompac, Crestine, Diamond/Dahgren Dampeners. Just a sample of the roller kits we have available. All kits listed are **SOFT INK ROLLER KITS**. See our complete SYn-Tac® roller catalog online @ www.ppsnj.com/rollers.htm. Lith-O-Roll & OEM rolls available upon request. Check your roller diameters before ordering. **PRICES LISTED REFLECT KIT DISCOUNT PRICE AND CANNOT BE COMBINED WITH ANY OTHER DISCOUNTS OR OFFERS.**

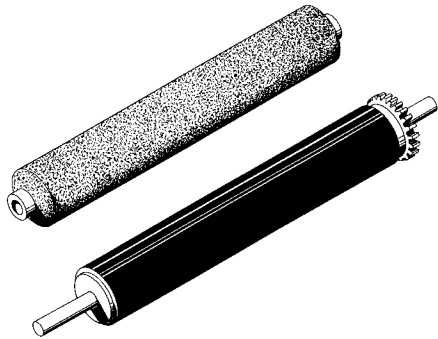

HAMADA: 500, 550, 600, 660, 665, 601, 602, 611, 612, 661, 662, 700, 770, 775, 800, 880, C-248, C-252, RS34, VS34

P-30426 600, 600CD NS 5 rollers \$242.46
 1) P-10610 small form
 1) P-10611 large form
 2) P-10620 dist.
 1) P-10630 ductor

P-30436 612CD, 612XL 6 rollers \$283.81
 1) P-10210 small form
 1) P-10211 large form
 3) P-10221 dist.
 1) P-10230 ductor

P-30432 700, 700CD/DX/CDX,E47 6 rolls \$355.86
 1) P-10110 small form
 1) P-10111 large form
 2) P-10120 large dist.
 1) P-10121 small dist.
 1) P-10130 ductor

CHIEF: 15, 115, 215, 17, 117, 217, X-Series & Super Chief

P-30450 17, 117, 217 6 rollers \$272.77
 2) P-17011 form
 2) P-17021 top/bottom idler
 1) P-17020 back idler
 1) P-17030 ductor

DAVIDSON: 221, 241, 242, 251, 500, 501, 502P, 600, 700, 701, 702P

P-30486 600, 700, 701, 702P 5 rollers \$289.62
 1) P-70110 form
 1) P-70111 form
 2) P-23020 ductor/dist.
 1) P-23021 front dist.
 * w/sloppy bushing

ABDICK: 350, 360, 375, 385, 9800, 9880

P-30608 360, 8800 NS 5 rollers \$195.25
 1) P-36010 upper form
 1) P-36011 lower form
 2) P-36020 dist. 1" dia.
 1) P-36030 ductor

P-30480 375, 9800 5 rollers \$217.05
 1) P-37010 upper form
 1) P-37011 lower form
 2) P-37020 dist. 1" dia.
 1) P-37030 ductor

P-5097 375, 9800 Pro 7 rollers \$289.70
 1) P-37010 upper form
 1) P-37011 lower form
 4) P-37020 dist. 1" dia.
 1) P-37030 ductor

HEIDELBERG: WINDMILL, GTO46/52, KORD62/64, QUICKMASTER 46 & OTHER MODELS

P-30457 GTO 46 9 rollers \$702.85
 6) P-46H10-B blue form,dctr,dist.
 1) P-46H10-Y yellow form
 1) P-46H10-W white form
 1) P-46H10-R red form

P-30459 GTO 52 9 rollers \$767.88
 6) P-52H10-B blue form,dctr,dist.
 1) P-52H10-Y yellow form
 1) P-52H10-W white form
 1) P-52H10-R red form

P-QM46-KIT 1st Unit

TOWNSEND T-51: all models available

P-30462 ABDick 9800 5 rollers \$226.21
 1) P-51710 form
 1) P-51711 form
 1) P-51721 transfer roll
 1) P-51750 transfer roll
 1) P-51730 ductor

P-30650 Ryobi 3200 Swing-Away 5 rollers \$230.13
 1) P-51713 form
 1) P-51714 form
 1) P-51720 transfer roll
 1) P-51722 transfer roll
 1) P-51730 ductor

MULTI: 1218, 1250, 1250LW, 1330, 1360,1650, 1850, 1860, 1870, 1960, 1962

P-30479 1250N,1250W/LW11" 5 rollers \$166.15
 2) P-12210 form
 2) P-12222 dist. 7/8" dia.
 1) P-12230 ductor

P-30471 1330, 1360, 1650 std. 5 rollers \$206.70
 1) P-13011 upper form
 1) P-13012 lower form
 2) P-13021 dist.
 1) P-13031 ductor

P-30478 1850, 1870 1st head 5 rollers \$271.80
 2) P-18010 form
 2) P-18020 dist.
 1) P-18030 ductor

RYOBI / ITEK: 2700, 2800, 3200, 3302, 500 series, / 950, 960, 975, 985, 3985

P-30445 2800,960 5 rollers \$233.20
 1) P-28010 upper form
 1) P-28011 lower form
 2) P-28020 dist. 1-1/4" dia.
 1) P-28030 * old style ductor

P-30446 3200,975 5 rollers \$252.45
 1) P-32R11 upper form
 1) P-32R12 lower form
 2) P-32R20 dist. 1-11/32" dia.
 1) P-32R33 * new style ductor

P-30456 3302,3985,ABDick3985 9 rollers \$498.30
 1) P-32R13 small form
 1) P-32R14 large form
 1) P-32R15 medium form
 3) P-32R24 dist.
 1) P-32R26 dist.
 1) P-32R27 dist.
 1) P-32R34 * new style ductor

TOKO: 1800,4700,4750 & R2

P-5092 4700 5 rollers \$282.70
 1) P-47010 form
 1) P-47011 form
 2) P-47020 dist.
 1) P-47030 ductor
P-5094 4750 6 rollers \$373.00
 1) P-47012 form
 2) P-47013 form
 2) P-47020 dist.
 1) P-47030 ductor

Has your press ever been **down** due to a broken spring or pin? **Eliminate costly down time** with your own emergency repair kit designed for your model press. Emergency and Combination kits for: ABDICK, CHIEF, DAVIDSON, HAMADA, HEIDELBERG, ITEK, MULTILITH and RYOBI.

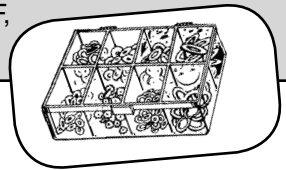

EMERGENCY KITS - ABDICK:

P-1707 Master Kit 720pc	\$262.90
P-1701 Nut Kit 100 pcs	\$44.00
P-1702 Washer Kit 120 pcs	\$52.90
P-1703 Screw Kit 108 pcs	\$58.19
P-1704 Ring Kit 228 pcs	\$79.80
P-1705 Pin Kit 136 pcs	\$59.80
P-1706 Spring Kit 28 pcs	\$55.00

P-5088 Junior Kit 434 pcs	\$126.00
---------------------------	----------

P-ACK Combo Kit 392 pcs	\$179.95
Ring Kit 228pcs	
Pin Kit 136pcs	
Spring Kit 28pcs	

EMERGENCY KITS- HEIDELBERG:

P-30397 Master Kit 418pc	\$219.90
P-30392 Nut Kit 43pc	\$21.50
P-30396 Washer Kit 60pc	\$40.00
P-30393 Screw Kit 168pc	\$96.00
P-30395 Ring Kit 47pc	\$28.90
P-30394 Pin Kit 100pc	\$37.50

P-HECK Combo Kit 147pc	\$59.95
consists of:	
Ring Kit 47 pcs	
Pin Kit 100 pcs	

KITS FOR MULTILITH:

P-1776 Master Kit 435pcs	\$359.80
P-1772 Nut Kit 60 pcs	\$44.80
P-1773 Screw Kit 62 pcs	\$175.78
P-1774 Pin Kit 86 pcs	\$52.90
P-1775 Spring Kit 85 pcs	\$139.80
P-1777 Wash/Ring 136 pcs	\$63.90

P-30328 Junior Kit 217 pcs	\$199.90
----------------------------	----------

P-MCK Combo Kit 319 pcs	\$230.95
Washer & Ring Kit 136 pcs	
Pin Kit 86pcs	
Spring Kit 85pcs	

KITS FOR CHIEF:

P-1765 Master Kit 880 pcs	\$459.80
P-1763 Nut Kit 60 pcs	\$31.90
P-1764 Washer Kit 68 pcs	\$31.90
P-1760 Screw Kit 376 pcs	\$175.90
P-1761 Ring Kit 100 pcs	\$39.80
P-1762 Pin Kit 180 pcs	\$99.80
P-30326 Spring Kit 96 pcs	\$299.80

P-CCK Combo Kit 376 pcs	\$399.90
Ring Kit 100 pcs	
Pin Kit 180 pcs	
Spring Kit 96 pcs	

METRIC KITS for HAMADA and RYOBI /

Emergency kits:	
P-30376 Master Kit 513 pcs	\$239.80
P-30373 Nut Kit 42 pcs	\$21.80
P-30372 Washer Kit 68 pcs	\$49.90
P-30371 Screw Kit 132 pcs	\$77.90
P-30374 Ring Kit 103 pcs	\$55.80
P-30375 Pin Kit 168 pcs	\$99.90

P-RCK Combo Kit 271 pcs	\$139.95
consists of:	
Ring Kit 103 pcs	
Pin Kit 168 pcs	

KITS FOR DAVIDSON:

Emergency kits:	
P-1771 Master Kit 1053 pcs	\$439.80
P-1769 Nut Kit 87 pcs	\$44.80
P-1770 Washer Kit 79 pcs	\$44.80
P-1766 Screw Kit 447 pcs	\$248.38
P-1767 Ring Kit 105 pcs	\$39.80
P-1768 Pin Kit 234 pcs	\$119.80
P-30327 Spring Kit 101 pcs	\$239.90

P-DCK Combo Kit 440 pcs	\$359.95
consists of:	
Ring Kit 105 pcs	
Pin Kit 234 pcs	
Spring Kit 101 pcs	

UNIVERSAL O.S / N.S. BLANKET CYLINDER

REPAIR KIT FOR MULTILITH 1250 SERIES

If you'd rather not buy a new or resurfaced blanket cylinder, you can save time and money by fixing it yourself.

P-5063 Repair Kit (comes with instructions)	\$338.00
---	----------

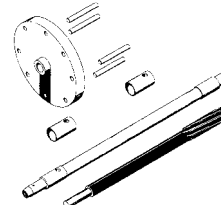

WASH-UP BLADES

P5075	GTO 46	\$38.90
P30203	GTO 52	\$38.90
P30231	GTO Numbering 46	\$50.00
P30784	GTO Numbering 52	\$40.90
P30218	KOR/KORA	\$44.30
P30268	Kord 62	\$48.00
P30222	Kord 64	\$48.00
P30230	KORS	\$46.40
P30264	KSBA	\$44.00
P30269	MO, (SORK gray machine)	\$40.90
P30261	MO, (SORK black machine)	\$40.90
P30267	MO	\$39.00
P30279	Quickmaster 46 & 46DI	\$20.00
P30275	RZO Rotaspeed	\$66.00
P30272	SORD (37-3/4 x 2)	\$44.00
P30273	SORD (37-3/4 x 2-3/8)	\$58.90

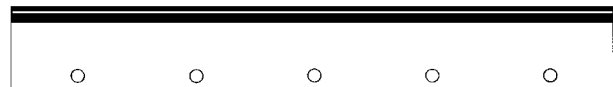

P31301	SORD SORDZ (36-7/16 x 1-9/16)	\$38.90
P30271	SORMZ Speedmaster 72	\$44.00
P30270	SORMZ Post Drupa	\$48.90
P30286	SORZ	\$42.90
P30274	Speedmaster (41 x 2-3/8)	\$41.90
P30276	Speedmaster (41-7/16 x 1-5/8)	\$50.00
P30277	Speedmaster 102	\$48.90
P30235	Speedmaster 74	\$48.90
P30242	TOK	\$18.90
P30209	Windmill 10 x 15	\$44.00
P30243	Windmill 13 x 18	\$44.00

EKLIND CUSHION GRIP HEX KEY SETS Standard & Metric sizes



Standard Sizes 3/32" - 3/8"	Sizes 3/32" - 1/4"
With Stand	Pouch
#50160-\$41.56	#53168-\$20.95
10 pc 6"	8 pc 6"
#50190-\$43.60	#53198-\$23.00
10 pc 9"	8 pc 9"

Metric Sizes 2mm - 10mm	2mm - 6mm
#56168-\$36.82	#55166-\$17.50
8 pc 6"	8 pc 6"
#56198-\$39.68	#55196-\$19.15
8 pc 9"	8 pc 9"

VIDEO REPAIR TAPES

This Old Press is a full color professionally made film documenting repairs for the ABDick 350, 360, 375, & 385 presses or the Multi 1250, 1250LW, & 1850 presses. Tapes include: troubleshooting the feed table; impression cyl. adjustments; the clutch pulley, etc... \$105.80 Your Choice:

P-1714 for ABDick Spanish **P-30006**
P-1715 for Multilith Spanish **P-30005**



Pro-Tips includes 2 tapes with 120 minutes of advanced press techniques including mixing PMS colors, spray powder, operating the 360CD and 9800CD series, plus workbook for the ABDick. **P-1717** Pro-Tips Video for the ABDick-\$260.00

EKLIND BALL-HEX-L™ KEYS

Standard Sizes From .050" to 3/8"

EK-13207 7 pc set \$8.86
EK-13211 11 pc set \$11.90
EK-13213 13 pc set \$18.40



Metric Sizes From 1.5mm to 10.0 mm

EK-13607 7 pc set \$8.40
EK-13609 9 pc set \$15.30

SPRING HOOK PULLER and PUSHER



B10-231 Push Type \$5.95
B10-230 Puller Type \$5.95

SNAP RING PLIERS \$18.65

B10-270-E External
B10-270-I Internal

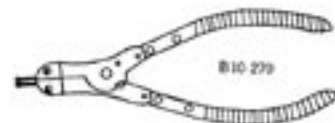

UNIVERSAL TAPER PIN KIT

Consisting of 18 taper pins-3 sizes (6 of each). Tap it in and cut off the excess and still have the remainder for other pin holes.

P-10500 \$14.50

MULTI PURPOSE GREASE

P-1833 Lubriplate
 14 oz. can \$12.00



PUMP OIL-DTE25

P-1586 quart \$19.00
P-1587 pint \$9.10



MACHINE OIL

P-1832 1/2 pint \$5.50



Got Dirt?

Rough Touch
SCRUBS
 IN-A-BUCKET®

GL-42272-1 Bucket of 72 \$15.39
GL-42272 Case of 6 \$92.35

SHOP TOWELS

#BJ-40 \$23.05

100% Cotton
 75 per Bag
 Completely Washable

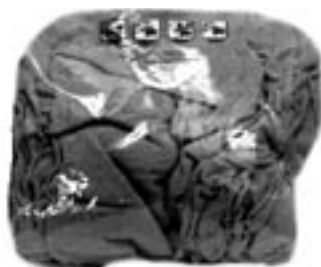

PIN PUNCH SET #S-565WB \$42.00
POUCH #S-565P \$36.55



VARN KOMPAC II® AUTOMATIC DAMPENERS AND COMMON PARTS & ROLLERS

Key advantages & cost justification of the Kompac:

AUTOMATIC INK/WATER BALANCE - With the Kompac II and its automatic ink/water balance, you have clean copy with 3rd sheet saleable no matter what the image. You can run the heaviest color coverage with oil, rubber, metallic or fluorescent inks. Any type of ink on any plate.

REDUCES STOCK WASTE - Poor ink/water control is the greatest cause of stock waste in offset printing. Instant start-ups, automatic ink/water control & the consistency of the Kompac radically reduce waste. The Kompac system will save 5% and more of annual stock purchases.

IMPROVED PRINT QUALITY. BRIGHT, SHARP COLORS AND DENSE SOLIDS - With the Kompac System, ink is milled into the fountain solution. This permits printing larger solids, fine screens, tiny reverses and crisp halftones. Many printing jobs farmed out or scaled up to larger equipment can now be run more profitably on a smaller offset press. Improved print quality is one of the major advantages of the Kompac

PARTS FOR KOMPAC:

ROLLERS:

Item#	Description	Model #	Price
V-92440	10-5/8 Metering	AF15, AF15G	\$208.95
V-92450	10-5/8 Form	AF15, AF15G	\$164.85
P-92K12	Syn-Tac 10/5/8 Form	AF15, AF15G	\$132.60
V-91301	10-5/8 Osc	Kolormate 10	\$165.40
V-92400	11 Metering	AF17, AF17G, M125ML/S, M2629, GST12	\$208.95
V-92410	11 Form	same as above	\$164.85
P-92K10	Syn-Tac 11 Form	same as above	\$132.60
V-92420	11-1/8 Metering	AB5060, AB880	\$208.95
V-92430	11-1/8 Form	AB5060, AB8800	\$164.85
P-92K13	Syn-Tac 11-1/8 Form	AB5060, AB8800	\$132.60
V-91302	11 Oscillator	Kolormate 20	\$165.40
V-92520	11-1/2 Metering	RYB2728	\$208.95
V-92530	11-1/2 Form	RYB2728	\$164.85
V-91303	11-1/2 Osc	Kolormate 30	\$165.40
V-92500	12-9/16 Metering	HMD600	\$219.95
V-92510	12-9/16 Form	HMD600	\$175.85
P-92K14	Syn-Tac 12-9/19 Form	HMD600	\$142.80
V-91305	12-9/16 Osc	Kolormater 50	\$165.40
V-92460	13 Metering	AB9875, AB9800, MD6112, M1316, GST13, GST413	\$219.95
V-92470	13 Form	same as above	\$175.85
P-92K11	Syn-Tac 13 Form	same as above	\$153.00
V-91306	13 Osc	Kolormate 60,61	\$165.40
V-92540	12-11/32 Metering	RYB3200	\$208.95
V-92550	12-11/32 Form	RYB3200	\$164.85
V-91304	12-11/32 Osc	Kolormate 40	\$165.40
V-92694	12-7/8 Metering	Chief XLK	\$219.95
V-92693	12-7/8 Form	Chief XLK	\$175.85
P-92K16	Form	GTO 52	\$200.95

For proper ordering, have model & serial # of Kompac unit

FASTER PRINT SPEEDS - The Kompac II prints a thinner film of ink and water. Besides jobs turning over faster, those tough jobs containing larger solids and screens, tiny reverses and those using lightweight stock, NCR etc., which traditionally can now be run at normal press speeds. Most regular jobs can be run at faster press speeds with improved print quality.

THE THEORY AND EXPLANATION OF KOMPAC

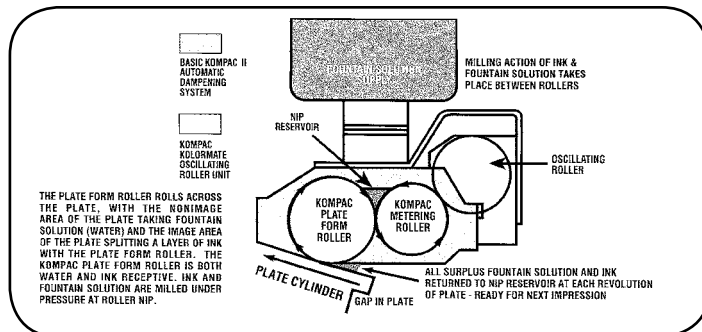

Item#	Description	Model #	Price
V-94240	13-1/4 Metering	RYB33, RYB330, TK47	\$270.11
V-94250	13-1/4 Form	TK47, TK4750	\$202.90
V-91900	13-1/4 Form	RYB33, RYB330	\$202.90
V-92K15	13-1/4 Form	RYB33, RYB330	\$163.20
V-92560	18 Metering	HMD700, HMD470	\$297.65
V-92570	18 Form	HMD700, HMD470	\$203.95
V-98330	18 Form upgrade kit	HDM700	\$259.45
V-91307	18 Osc	Kolormate 70	\$200.00
V-94330	18-3/8 Metering	M1819-1	\$303.20
V-92040	18-3/8 Form	M1819-1	\$214.95
V-94950	18-3/8 Form upgrade kit	M1819-1	\$312.50
V-92710	23-1/4 Metering	AB3850, AB8090	\$319.20
V-92720	23-1/4 Form	AB3850, AB8090	\$226.00
V-91308	23-1/4 Osc	Kolormate AB3850/8090	\$209.50
P-30083*	Old Style Teflon Seals		\$ 9.95
V-92280	Backing Plate Retro Fit Kit for NS Seals		\$ 99.25
P-30093*	New Style Teflon Seals		\$ 9.95
P-30714	New Style Teflon Seals 5 pak		\$ 46.00
P-30715	New Style Teflon Seals 10 pak		\$ 90.00
P-11744	Cleaning Seals 12 sets		\$ 17.00
V-92380	RH & LH Backing Plates		\$ 38.55
V-92236	Tab Spring for Backing Plate		\$ 2.25
V-92303	Seal Plate Shield Screw		\$ 4.36
V-92691	Cover Nut		\$ 3.35
V-92760	Water Bottle Cap & Valve		\$ 14.55
V-92771	Water Bottle		\$ 7.75
P-30088	Syringe		\$ 2.85
V-91111	Dog for Osc Roller		\$ 21.85



P-30083 Old Style



P-30093 New Style

CRESTLINE DAMPERS, ROLLERS, PARTS AND CHEMISTRY

Crestline® Altra Series Dampener

The *Crestline Altra Series Continuous Feed Dampener* provides instant ink and water balance, runs without alcohol and installs quickly without altering the press. The *Crestline Altra* features a press driven oscillator for improved milling of ink and water, a removable form roller and is adaptable to any circulator. Available for AB Dick 9985; Didde 8.5; Apollo 11 & 17, DG175, MCP; Hamada C248, C252; Heidelberg GTO46, GTO52, MO; Itek 3985; Ryobi 3302; Sakurai 52, 52E, 252, 58, 258E; Shinohara 52S, 65/66, 65IIP/66IIP

Crestline® Continuous Feed Dampener

Designed for small offset presses, the *Crestline Continuous Feed Dampener* provides instant ink & water balance, runs without alcohol, and is segregated from the ink train to prevent moisture for migrating back into the ink fountain. Installation can be done in just a few hours, without altering the press, and operator training can be achieved in less than an hour. **Available for:** AB Dick 350, 360, 375, 8800, 9800, 9870, 9900; Multi 1218, 1250, 1360, 1450, 1650, 1850, 1860, 1960; Hamada DU34DL, E47, E47S, RS/VS, SU47, 500CDA, 600, 665, 611, 611E, 612, 612E, 700, 775; Imperial 2200, 3200, 4200; Itek 950, 960, 975, 985; Ryobi 2700, 2800, 3200, 3200E, 3200MCD, 500N; Toko 1800, 4700; Townsend T-51 for ABDick 360 (stationary only) 8800, 9800; Itek 950, 960, 975, 985; Ryobi 2700, 2800, 3200, 3200E, 3200MCD

We carry the complete line of parts, rollers and chemistry for all Crestline Dampeners

**The following is a list of the more common rollers for Crestline Dampeners. For more information and other presses no listed here go to www.ppsnj.com/crestline/crestline_fup/htm
Please be sure to have Crestline Model Number & Serial Number when ordering.**

Item #	Description	Price	Item#	Description	Price
FOR MODEL RYOBI 2700/2800			P-29121-S	INTERMEDIATE ROLL SHELL ONLY	119.30
P-31559	FORM ROLLER	127.50	FOR MODEL RYOBI 3302/3985/9985 6 ROLL)		
P-31562	PAN ROLLER	125.90	P-31571	WATER FORM	126.30
P-29101	OSC ROLLER	133.10	CR-X07-0321	PAN ROLLER	163.35
P-29100	METER ROLLER ASY	168.45	P-29109	OSC ROLLER	140.30
P-29100-S	METERING ROLLER SHELL ONLY	121.90	P-31569	UPPER INTERMEDIATE	160.35
FOR MODEL RYOBI 3200/975			CR-XSA-070512	LOWER INTERMEDIATE ROLL	199.65
P-29105	FORM R3200/975	124.70	P-31570	METERING ROLL	148.30
P-29107	PAN R3200/975	125.90	P-31570-S	METER ROLL SHELL	119.30
P-29106	OSC R3200/975	143.80	FOR MODEL AB DICK 9800/9900 SERIES		
P-29104	METERING ROLL ASY	179.10	P-31506	FORM ROLL	123.30
P-29104-S	METERING SHELL ONLY	119.40	P-31504	PAN ROLL	125.80
FOR MODEL RYOBI 3200E			P-29103	OSC ROLL	141.20
P-31565	FORM ROLLER	126.80	XSA-070203NS	METERING ROLL	196.90
P-29108	PAN ROLLER	125.90	FOR HAMADA - MISC		
P-29103	HARD OSC ROLLER	141.20	P-29127	FORM H-C248	212.25
CR-XSA-070243	HARD METER ROLL ASY	196.90	P-29126-S	METER H-C248 SHELL	141.20
FOR MODEL RYOBI 3302/3985/9985 (4 ROLL)			P-29134	FORM ROLL H-RS/V34	133.45
P-31571	FORM ROLLER	126.30	CR-X07-0350	PAN ROLL H-RS/VS34	195.00
P-31509	PAN ROLLER	129.10	P-29136	PAN H-600/611/612	139.70
P-29109	HARD OCS ROLLER	140.30	MISC.		
CR-XSA-070204NS	METERING ROLLER ASY	199.65	P-1915	WATER BOTTLE ASSY	18.75
FOR MODEL RYOBI 3302/3985/9985 (5 ROLL ALTRA)			CR-X99-28-OEM	HOSE _ X 16	1.10
P-29123	FORM ROLLER	128.95	CR-X99-01	CLICKER PLATE	4.75
CR-XSA-070338	PAN ROLLER ASY	192.50	CR-X55-01	COMPX ROLL DEGLAZER	30.00
P-29124	HARD OSC ROLLER	165.70	CR-X55-05	FC1000 FOUNTAIN SOL	30.00
P-29122	METERING ROLL ASY	151.35	CR-X55-06	APA FOUNTAIN ADDITIVE	30.00
P-29122-S	METER ROLL SHELL ONLY	119.30	CR-X55-18	MP FOUNTAIN SOL CON	30.00
P-29121	INTERMEDIATE ROLL ASY	154.00	PRICES SUBJECT TO CHANGE WITHOUT NOTICE		



bigfoot™

Bigfoot features a spring loaded vacuum controlled piston (just like the big boys) that gives the best sheet seeking action you've ever seen. Self adjusting, **Bigfoot** doesn't care how uneven the stack is and eliminates the problem of dragging your feet over wet ink. As soon as it finds the sheet, **Bigfoot** retracts and stays that way until the sheet is in-fed, then goes for the next one. You get perfect separation, every time. No more messing

around with spring loaded feet that tend to punch holes in the stock, or trying to fine tune the ones that come with the press as you go from one job to the next. The only adjustment you'll ever have to make with **Bigfoot** is for the size of the stock.

Part#		Press Model
P-30762	\$280.00	ABDick (4 pc)
P-30363	\$138.00	ATF Chief 15-217
P-30360	\$143.00	ATF Chief X-Series & Super Chief 2000
BF-1007	\$325.00	ATF Chief 20, 22, 29, (2 sets w/brackets)
P-30364	\$143.00	Davidson (2 pc)
P-30365	\$215.00	Davidson (3 pc)
P-30763	\$138.00	Gestetner 311, 312, 313
P-30370	\$175.00	Hamada 500, 600, 665 (2pc w/brackets)
P-30759	\$325.00	Hamada 700, 800, 880 (4pc w/brackets)
P-30386	\$280.00	Hamada 611, 612, 662, E47 (4 pc)
BF-1040	\$325.00	Kluge (4pc w/brackets)
P-30832	\$170.00	Miehle Vertical (2pc w/brackets)
P-30370	\$175.00	Multi Old Style 1250 (2pc w/brackets)
P-30361	\$138.00	Multi New Style 1250, 1360, 1650
		(2pc)
P-30362	\$204.00	Multi 1850 (3 pc)
P-30366	\$275.00	Multi 1850N, 1860, 1870 (4 pc)
P-30760	\$280.00	Ryobi (4 pc alum. tube)
P-30761	\$280.00	Ryobi (4 pc black tube)
BF-1030	\$280.00	Toko (4 pc)
BF-1031	\$413.00	Toko (6 pc)
P-1555-66	\$.35	Sucker feet
P-30707	\$4.50	Graphite

OFFSET MASTER PLATE PUNCHES

Converts roll & pre-cut straight edge masters into pinbar. Keeps plate straight. Improves registration for better print quality.



JP-OPL/25	\$435.00	up to 12-1/2"
JP-OPS/36/1	\$959.00	up to 18"

PRICES SUBJECT TO CHANGE WITHOUT NOTICE.

THE IONIX™ STATIC ELIMINATOR

Now coated stock runs like offset. 70# coated will run like 60# offset. 3, 4, 5 part carbonless will run like 20#. Your press will run faster with less paper jams.

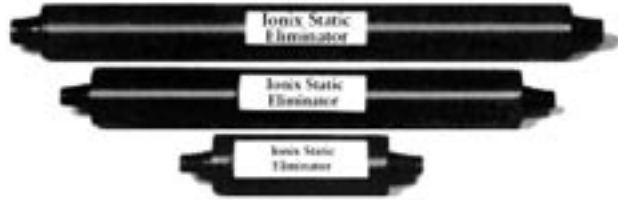

NEW TECHNOLOGY-The Ionix utilizes an entirely unique patented technology to neutralize static in materials. Therefore, unlike any other static eliminators, the presence of metals in its path has no effect on its operation.

EASE OF INSTALLATION-The Ionix installs in less than 10 minutes on any airline. Simply cut the main blower line from the compressor going to the blow hose in your feeder. To install the unit, simply slip on the hoses over the tapered barb nozzles on the Ionix filter.

WIDE RANGE OF APPLICATIONS -The Ionix has been installed throughout the world on presses as small as ABDick 350 to presses as large as Harris 77", as well as folders, collators, laminators, sheeters, saddle binders, mailing machines, screen presses, high speed copiers and material handling equipment.

HOW IT WORKS -Paper develops an electrical attraction between the sheets of paper which causes them to stick together. The Ionix utilizes the air going to your feeder to de-ionize the paper. When the blower air passes through our filter, the air is given an ionizing charge. When blown between the sheets of a paper, the Ionix ionized air immediately neutralizes the charged sheets and the sheets electrically separate from themselves. ANY paper will run easier and faster, since essentially the paper is made "slippery" electrically.

FOR SHEET FED PRESSES & FOLDERS

Model 100	for presses/folders sheet size up to 14" x 19"	\$94.00
Model 200	for presses/folders sheet size up to 22" x 34"	\$129.00
Model 300	for presses/folders sheet size up to 26" x 40"	\$169.00

Please provide blower hose inside diameter when ordering: 1/4"; 1/2"; 3/4"; 1"; 1 1/4".

PRINTERS PARTS STORE

800-543-1117 FAX: 800-392-4072

ORDER TODAY!!

SAVE COD FEES-WE ACCEPT

VISA*MASTER CARD* AMERICAN EXPRESS and CHECKS-BY-FAX

REPLACEMENT PARTS FOR BAUM FOLDER, M.B.M. and PROFOLD

FOR BAUM FOLDER



Part#	Tires (in order of O.D. x I.D.)	Prices
B-3750	Caliper Tire 1-11/16" x 15/16" x 1/2"	\$7.95
B-45290	Roller Tire 1" x 15/32" x 1"	\$4.75
B-48429	Roller Tire 13/16" x 1-3/32" x 1"	\$6.35
B-50080	Tire Sucker Wheel 1-3/4" x 7/16" x 1/4"	\$9.95
B-6402	Pull Out Band 11/16" x 7/16" x 1/4"	\$4.95

Perforating Wheels



B-7618	6 Tooth	\$12.90
B-7895	15 Tooth	\$16.55
B-7896	18 Tooth	\$16.55
B-7619	24 Tooth	\$10.95
B-6798	31 Tooth	\$12.55
B-7791	41 Tooth	\$ 8.75
B-11962	64 Tooth	\$12.50



B-6346	Stacker Belt	\$268.75
B-20925	Register Belt	\$ 29.65
B-21679	Register Belt	\$ 42.71



B-6438	Stripper	\$13.25
---------------	----------	---------



Part#		Prices
B-50498	Sheet Detector Tab	\$5.25



B-48429-K	Tire Kit for Baum 714	\$21.90
------------------	-----------------------	---------

B-6402-K	Tire Kit for Baum 417, 200, 400, 600, Mark I, Mark II, Junior Jet	\$38.00
-----------------	--	---------



B-3750-K	Tire Kit (4)	\$29.90
-----------------	--------------	---------



PERFORMANCE KITS FOR MBM FASTFOLD:

MI-1	consists of:	\$96.90
-------------	--------------	---------

3 MI-AA1462	Auto Feed Wheels	
--------------------	------------------	--

2 MI-AA1121	Rubber Wheels	
--------------------	---------------	--

1 MI-AA1077	Abrasive Wheel	
--------------------	----------------	--

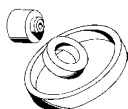

FOR PROFOLD 1117FM, 1118FM

PF-1	consists of:	\$69.90
-------------	--------------	---------

1 PF-109696	Feed Wheel Tire	
--------------------	-----------------	--

2 PF-3342	Pull Out Tires	
------------------	----------------	--

2 PF-10977	Slides	
-------------------	--------	--

1 PF-109624	Stationary Roll	
--------------------	-----------------	--

DUROWEAVE™ DAMPENING COVERS

Duroweave - The Premium Sheared Surface Dampening Cover for Duplicators, Sheetfed and Web Presses. Soft synthetic fibers, seamless construction. Cleans easily with tap water in less than one minute. Guaranteed lint free - run really clean solids. Shrinks for a tight fit - guaranteed not to "walk".



Provides durable, long lasting performance. Packaged in pre-cut lengths with drawstrings on both ends for duplicators & smaller sheetfed and web presses. Also available in: 5, 10 and 20 yard rolls for larger sheetfed and web presses.

VERATEC RED RUNNER™ DAMPENING SLEEVES are long lasting, clean up easily and are lint-free. Red Runner's unique and patented fiber system delivers unprecedented control of ink and water balance. And it's consistent and ultra fine surface provides a new level in pattern-free performance. There are no low spots, tracking or morning bands. And, unlike rigid tubes, Red Runner Dampening Sleeves can't break, crack or split. Available for all 3M® water form rollers. Some of the popular sizes are:

Part#	Press Model	Price
K-B14	Multi 1250 series, 1330, 1360, 1650; Hamada 600, 612; Chief 15, 17	\$18.90
K-B20	Multi 1850, 1860, 1960; Ryobi 3200, 3302, 3985	\$25.30
K-C12	Chief 15, 17; Davidson 500 series	\$18.40
K-C19	Davidson 700 series	\$25.30

Please call 800-543-1117 for pricing on models not listed for Duroweave and Red Runner Dampening Sleeves
We also carry JOMAC GREENSLEEVES & WATERSLEEVES- call for pricing

AEROSOLS FOR GRAPHIC ARTS, HS BOYD PERF & SCORE

SPRAY ADHESIVE

for use in the art studio, sign shop & graphic arts department. Water resistant, non-wrinkling, quick or long tack for temporary or permanent bond.

SW-66 \$7.95



RUBBER CLEANER AND REJUVENATOR

returns life to ink laden hardened rollers and blankets. Removes glaze from gum, friction, ink, coatings and oxidation. Restores velvety smooth finish.

SW-203 \$6.95



SPRAY ADHESIVE

for use in the art studio, sign shop & graphic arts department. Water resistant, non-wrinkling, quick or long tack for temporary or permanent bond.

SW-66 \$7.95



RUBBER CLEANER AND REJUVENATOR

returns life to ink laden hardened rollers and blankets. Removes glaze from gum, friction, ink, coatings and oxidation. Restores velvety smooth finish.

SW-203 \$6.95



VARN AEROSOLS



INKREAD! Anti Skin aerosol contains no wax and will not affect color, consistency or drying speed. Spray on ink rollers and ink fountain. Spray new rubber to reduce oxidation, roller ends to prevent glazing and cracking.
\$7.60

ANTI-STATIC SPRAY Eliminates static buildup on feedboards and stock. Kills static in one quick spray. Spray on printing & bindery equipment: presses, folders, cutters, conveyors, gluers, drive belts & anywhere frictions builds up.
\$7.80

GLASS CLEANER Professionally formulated for the graphic arts. Use on light and stripping tables, darkroom and vacuum frames. Anti-static action retards dust attraction and eliminates pin holes on negatives.
\$5.15

SILICONE SPRAY Adds slip to metal surfaces. Use anywhere paper contacts metal surfaces. Spray on impression, blanket and plate cylinders, feedboards, feeder and delivery wheels, cutting tables, etc...
\$8.80



WD-40 13.5 oz. can Stops squeaks, protects metal, loosens rusty parts and frees sticky mechanisms. \$4.15

HS BOYD OFFSET RULES

H.S. BOYD OFFSET RULES

Why give profits away? Keep profits where you want them-in house. H.S. Boyd Offset Rules attach to the impression cylinder of the press and enable the operator to perf, score, slit and punch on-press-while you print! Quality manufacturing steps provide you with products you can count on to perform consistently. This translates into lower costs and higher quality for your clients.

- Heat-treated for strength•Available in the original Side Series (SS) or new Center Series (CS) for increased pressure and longer runs
- Available in a variety of configurations for a multitude of applications•Sharpened with diamond-wheel sharpeners. **\$39.95 20' ROLL**

SIDE-SERIES BLADES

Litho-Perf / SS

•Boyd's first offset perforating product, the Litho-Perf continues to offer reliability and high quality performance. It is available with 6, 8, 12 or 16 teeth per inch and in heights from 12.5/1000 inch 29/1000 inch. This variety of blade heights gives the printer the ability to perform perforations on a multitude of stocks.



Litho-Score / SS

• Innovator of in-the-run, on press scoring, Litho-Score holds consistent register with the printed copy. The rule prepares the stock for a neater fold and is available in various heights for different stocks.



CENTER-SERIES (CS) BLADES

Litho-Perf / CS

•Offering the same on-press perforating performance as the standard side-series Litho-Perf, the Litho-Perf/CS has center mounted teeth for increased pressure and longer runs. This is the only center-mounted rule that has been heat treated for extended life.



Litho-Score/CS

•A new development for the offset press, the Litho-Score/CS has no sharp edges that could cut the stock. And the wider, rounded scoring edge will eliminate cracking on heavier stocks. H.S. Boyd Company is the sole manufacturer of these types of scoring blades available for paper or card stock.



MICRO-PERF is designed for use on any paper or lightweight card stock, ideal for perforating continuous feed forms. Perf line remains clean, no stray fibers or rough edges: 30, 40 or 50 tp.

\$39.95 10' ROLL

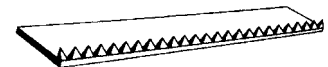

BLANKETS: Reeves Vulcan & SRF High Quality Blue 3 Ply Compressible. Also available in 4 ply. We have underblankets, 2 part stickie back blankets and Reeves R914 5 ply specifically for Ryobi/Itek models.

AB DICK

P-30052-PPS	350	15-3/16 x 10	\$19.87
P-30053-PPS	360/8805	18-1/2 x 10-5/8	\$25.72
P-30055-PPS	360/8805	18-1/2 x 11	\$26.63
P-30056-PPS	375	18-1/2 x 12-3/4	\$30.88
P-30057-PPS	9800	19-3/16 x 12-5/8	\$31.70
P-30059-PPS	385	18-3/4 x 22-5/8	\$55.90
A9880-PPS	9880/9890	19-1/4 x 22-3/4	\$57.31

CHIEF

P-30061-PPS	15,115,215	15-3/16 x 10	\$19.87
P-30063-PPS	17,117,217	18-9/16 x 11	\$26.64
P-30064-PPS	2000,2217	19-3/16 x 12-5/8	\$32.74
C20-PPS	20	16 x 20	\$36.78
C20A-PPS	20A	16 x 20-1/2	\$37.66
C22-PPS	22	22 x 22-5/8	\$56.33

Blankets available for all Chief and Solna models, please call

DAVIDSON

P-30066-PPS	500 series	16 x 10	\$21.04
P-30067-PPS	600	13-3/16 x 17-1/4	\$29.76
P-30068-PPS	700 series	16 x 17-1/4	\$36.12
P-30070-PPS	901	16-1/16 x 19-3/4	\$41.53

HAMADA

P-30072-PPS	500	16-1/2 x 10-1/2	\$22.68
P-30073-PPS	500CDA	16-1/2 x 11-7/8	\$25.65
P-30074-PPS	600	19-1/2 x 12	\$30.04
P-30075-PPS	601,602,611,612	19-3/8 x 12-3/8	\$29.44
P-30077-PPS	700	16-1/2 x 18	\$39.60
P-30078-PPS	770	16-1/2 x 18-3/8	\$39.68
P-30079-PPS	800	16-11/32 x 20-1/4	\$43.31

MULTILITH

P-30052-PPS	1250	15-3/16 x 10	\$19.87
P-30042-PPS	1250W	18-1/2 x 10-5/8	\$25.72
P-30046-PPS	1250LW	18-1/2 x 11	\$26.63
P-30048-PPS	1330,1360,1650	18-7/16 x 12-5/8	\$30.46
P-30050-PPS	1850,1860	16-1/16 x 17-5/8	\$37.06
P-30062-PPS	1218	20-1/4 x 12-1/4	\$30.53

RYOBI / ITEK - Reeves 914 5 Ply

Developed Specifically for Ryobi Presses

P-30081	2700,950	18-1/32 x 10-5/8	\$25.94
P-30082	2800,960	18-15/16 x 11-1/4	\$31.32
P-30084	2800XL	19-1/2 x 11-1/4	\$30.69
P-30085	3200,975A	18-15/16 x 12	\$16.90
P-30090	3200MCD,975M	18-15/16 x 13	\$33.36
P-30086	3200LC,975XL	19-1/2 x 12	\$31.71
P-30087	3200MCD,975MXL	19-1/2 x 13	\$35.89
P-30589	3200PFA,975PFA	19-1/4 x 12-1/4 *	\$43.20
P-30091	3302M	19-1/2 x 13-5/8 *	\$43.20
R3202M	3202M	19-1/4 x 13-1/2 *	\$43.20

* with bars

TOKO

TOKO4700-PPS	4700	20-3/8 x 12-3/8	\$30.72
TOKO4750-PPS	4750	20-3/8 x 13	\$32.32

HEIDELBERG-4 ply

P-30550	TOK	16 x 10-1/2	\$20.87
P-30551	GTO 46	17-5/16 X 18-1/8	\$38.12
P-30552	GTO 52	17-1/2 x 20-1/2	\$43.44
P-30553	KOR	18-1/2 x 22-1/2	\$50.24
P-30554	KOR	18-1/2 x 23-5/8	\$52.70
P-30555	KORA	20-1/4 x 23-5/8	\$57.60
P-30510	KORD 62	20-1/4 x 23-5/8	\$59.99
P-30557	KORD 64	20-5/8 x 26-1/2	\$65.66
P-30558	MO	22-1/4 x 26-1/2	\$71.74
P-30559	SORK-Z	22-1/4 x 26-7/8	\$73.18
P-30560	SORM	23-3/4 x 28-3/4	\$81.78
P-30561	SORM	23-3/4 x 29-5/8	\$84.26
P-30562	KORS	23 x 29-3/8	\$80.93
P-30563	SOR	27-1/8 x 33-1/2	\$108.50
P-30564	SORD	28-1/8 x 36-1/4	\$121.61
P-30565	RON	31-1/8 x 41-1/8	\$152.43
P-30566	SPEEDMASTER	31-1/8 x 41-3/8	\$153.35
Quickmaster	(with bars)	21-7/8 x 13-1/4	\$41.82

Save Time and Money on Blanket Changes with QUICK CHANGE BLANKET BARS

FOR ABDick

P-36777	360	\$129.90	P-36252	360	\$125.90
P-37777	375, 9800	\$139.90	P-37252	375,9800	\$136.00
P-38777	385 s/n 1305 & below	\$340.00	P-38252	385 s/n 1305 & below	\$300.00
P-988777	9880	\$380.00	P-988252	9880	\$380.00

REGULAR STYLE



VARN BLANKET FIX

V-SWELL 3 oz bottle w/brush \$7.95

PRESS WASHERS:

FOR ABDICK:

P-36773	350,360	\$195.00
P-37773	375/9800 old style	\$199.90
W-149-A	9800 new style	\$175.00

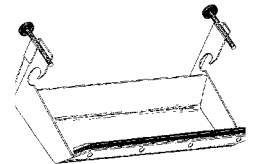

FOR MULTI:

P-12773 1250LW 11 x 17 \$256.00

FOR CHIEF:

P-30307 15 N.S., 115, 17 N.S., 117, 215-217 1st head \$130.00
 *C-309-051337A 2000 1st head & 2115, 2117 \$233.00



FOR DAVIDSON:

D-88-2257-02 500, 501, 502, 600, 601, 700, 701, 702 \$159.80

***FOR RYOBI:**

P-27773 2700, 2800/ITEK 950, 960 \$219.90
 P-32773 3200, 3200MCD, 3202 \$169.90
 P-32773P 3200PFA/ITEK 975PFA \$179.90

* Washup trays for Ryobi require brackets & are not included.

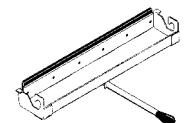

BASELINE CLEANER SHEETS

Part#	Model	Size
ABDick		
BL-1015-PB	350 PB	10-1/8 x 15-1/16
BL-1015-SL	350 SL	10-1/8 x 15-1/2
BL-ABD-360-PB	360	11-1/16 x 18-5/8
BL-ABD-375-PB	375	13 x 18-3/4
BL-ABD-9800-PB	9800	13 x 19-3/8
BL-MGD-20-SE	380 SC	15-5/8 x 20-5/8
BL-MGD-22A-SE	385,9880,9890 SC	19-1/4 x 22-7/8

AM MULTIGRAPHICS

BL-1015-PB	1250 PB	10-1/8 x 15-1/16
BL-1015-SL	1250 SL	10-1/8 x 15-1/2
BL-1118-PB	1250W PB	11-1/16 x 18-1/16
BL-M-1218-PB	1218,1218EI	12-3/8 x 18-5/8
BL-1330-PB	1330	12-7/8 x 15
BL-1360-PB	1360,1450,1650,1650 XE	18-1/8 x 15-1/16
BL-1850-PB	1850,1860,1870,1960	18-1/8 x 15-1/16

ATF CHIEF

BL-1015-PB	15,115 PB	10-1/8 x 15-1/16
BL-1015-SL	15,115 SL	10-1/8 x 15-1/2
BL-1118-PB	17,117,217	11-1/16 x 18-1/16
BL-ATF-2000-PB	2000 & X-Series	13 x 18-1/8

DAVIDSON

BL-D-221-SE	221,500 Series	10-3/16 x 16
BL-D-600-SE	600 SC	17-3/4 x 13-3/4
BL-D-233-SE	233,700 Series	17-7/8 x 16
BL-D-901-SE	901 SC	20-1/8 x 16-3/8

Part#	Model	Size
HAMADA		
BL-H-500-PB	500 PB	10-3/4 x 15-3/4
BL-H-500-SL	500 SL	10-3/4 x 15-3/4
BL-H-500CDA-PB	500CDA	11 x 15-1/2
BL-H-600-PB	600,660,665	11-7/8 x 18-1/8
BL-H-601-PB	601, 602, 611, 612, Duetto	12-1/8 x 18-3/16
BL-H-700-PB	700 PB	15-1/2 x 18-1/2
BL-H-700-SL	700 SL	15-3/4 x 18-1/2
BL-H-800-SL	800 SL	15-7/8 x 20-1/2
BL-H-800-17-SL	800 17 hole SL	15-1/2 x 20-1/2
BL-H-800-18-SL	800 18 hole SL	15-1/2 x 20-1/2

RYOBI / ITEK

BL-KR-2800-PB	2800,960	11-3/8 x 18-5/8
BL-KR-2800-CD-XL-PB	2800XL, 960	11-3/4 x 19-3/8
BL-KR-3200-18-PB	3200,975	13 x 18-5/8
BL-KR-3200-19-PB	3200LC,975XL	13 x 19-3/8
BL-KR-3200-MCD-18PB	3200MCD, 975M, 985	13-5/8 x 18-5/8
BL-KR-3200-MCD-19PB	3200MCDLC, 975XL, 985	13-5/8 x 19-3/8
BL-KR-3302-SE	3302,3985,9985	13-5/16 x 19-3/16

TOKO

BL-TOKO-4700-PB	4700 PB o.s.	12-3/8 x 18-5/8
BL-TOKO-4700-CD-PB	4700 PB n.s.	13-5/8 x 18-5/8
BL-ABD-9800-PB	4750 PB	13 x 19-3/8
BL-TOKO-4750-PB	4750 PB	13-5/8 x 19-3/8

SAVE MONEY - ORDER BY THE CASE FOR 10% DISCOUNT
We have cleaner sheets available for: Imperial, Miehle-MGD and Rotaprint. Please call for more information.

JUSTRITE® PLUNGER CANS



The best way to handle flammable liquids and other solvents used in "sponging and cleaning". Plunger cans have a spring-loaded plunger with perforated-metal fire-baffle dasher. Depressing the dasher moistens rag or sponge, and surplus drains back into can.

Part#	Capacity	Dia x Ht.	SizeDasher	Dia.	Price
P-5032	2 quart	7-1/4 x 8	5		\$54.90
JR-10008	1 pint	4-7/8 x 6	2-3/4		\$44.95
JR-10143	2-1/2 pint	4-3/4 x 8-1/4	5		\$48.80

DISPOSABLE GLOVES

W-158	50 pair large	\$14.00	Latex
GL-0900184A	50 pair large	\$14.42	Vinyl
LIT-GLV-NXL	50 pair large	\$20.00	Blue Nitrile

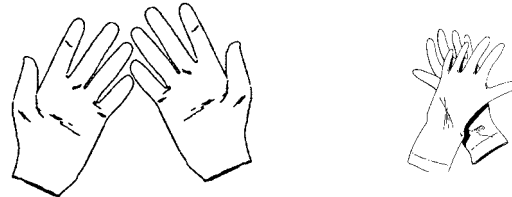

WEBRIL WIPES & HANDI-PADS

K-4X4	4" single pack	\$4.75
K-4X4-C	4" handi-pads	\$89.90/case
K-8X8	8" single roll	\$8.15
K-8X8-C	8" wipes	\$61.20/case



OLDEN DIGITAL MEMORY COUNTER

OL-TC \$289.00 OL-RTC Rate Counter \$329.00
Sensor mounts magnetically. Fits folders, stitchers, bindery equipment, mailing, inserting & packaging machines.

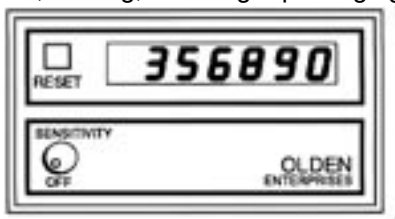

RTC
MODEL
SHOWN

BASELINE® MASKING SHEETS

Part #	Press #	Size	Price
AB DICK			
BL-ABD-350	350	10-1/16 x 16	\$24.65
BL-ABD-360A	360	11-1/16 x 18-1/2	\$36.20
BL-ABD-375	375	13 x 18-5/8	\$45.35
BL-ABD-9800	9800	13-1/8 x 19-15/16	\$45.35
BL-MGD-20	380	15-5/8 x 20-5/8	\$51.65
BL-MGD-22A	385,9880,9890	19-1/4 x 23	\$75.50

AM MULTIGRAPHICS

BL-M-1250-PB	1250 PB	10-1/16 x 15	\$24.65
BL-M-1250R-3	1250 SL	10-1/16 x 15-5/8	\$24.65
BL-M-1250-W	1250W	11-1/16 x 18-3/16	\$36.20
BL-M-1218	1218,1218EI	13 x 19-1/2	\$45.35
BL-M-1330-1360	1330,1360,1450,1650,1650XE	12-7/8 x 18-3/16	\$45.35
BL-M-1850	1850,1860,1870,1960	18-1/8 x 15-1/16	\$48.65

ATF CHIEF

BL-ATF-15	15,115	10-1/16 x 15-3/8	\$24.65
BL-ATF-17	17,117,217	11-1/16 x 18-3/16	\$36.20
BL-ATF-2000	2000 & X-Series	13-1/16 x 18-1/8	\$45.35
BL-ATF-125	ATF Solna 125,225,425	22-3/4 x 20	\$82.50

available for: 20,20A,24,124,126,226

DAVIDSON

BL-D-221/500	221,500	10-1/16 x 16	\$24.65
BL-D-600	600	17-5/8 x 13-3/4	\$48.65
BL-D-233/700	233,700	17-5/8 x 16-1/16	\$48.65
BL-D-901	901	20-1/8 x 16-3/8	\$51.65

Part #	Press #	Size	Price
HAMADA			
BL-H-500	500,550	10-7/8 x 15-13/16	\$36.20
BL-H-600	600,660,665	11-3/16 x 18-1/8	\$41.90
BL-H-601/602	601,602,611,612,Duette	12-1/16 x 18-1/8	\$45.35
BL-H-700	700,770	18-1/2 x 15-7/8	\$51.65
BL-H-800	800,880	20-5/8 x 16	\$51.65
BL-H-C248	C-248/E	15-7/8 x 18-5/8	\$51.65
BL-H-C252	C-252 Series		\$51.65

RYOBI / ITEK

BL-KR-290	2800,960	11-1/2 x 18-1/2	\$41.90
		fits 11, 11-1/4, 11-3/8, and 11-1/2" plates	
BL-KR-2800- CD-XL	2800CDXL	11-9/16 x 19-3/8	\$45.35
BL-KR-3200-13	3200,3200PFA	975 13" wide plate 13 x 19-1/2	\$45.35
BL-KR-3200-MCD	3200MCD,985	13-5/8" wide plate 13-5/8 x 18-5/8	\$51.65
BL-KR-3302	3302,3985,9985	13-1/4 x 19-1/4	\$45.35
BL-KR-480	480/480D/500N		\$51.65
BL-KR-522	520/512/522		\$51.65
BL-KR-582	580/582H		\$82.50
BL-KR-662	660/662H/662PFH		\$119.15

TOKO

BL-TOKO-4750 +R2		13-1/8 x 20	\$45.35
------------------	--	-------------	---------

HEIDELBERG

BL-TOK/TOM	T-Offset	10-5/8 x 15-3/8	\$36.20
BL-GTO-46	GTO 46	18 x 15	\$48.65
BL-GTO-52	GTO 52	20-1/4 x 15-7/8	\$51.65
BL-KORD-64	KORD 64	25-3/4 x 21-5/8	\$82.50
BL-QM-46	QUICKMASTER 46		\$51.65
BL-SM-52	SPEEDMASTER 52		\$75.50

also available for: KOR, KORA, KORD 62, KORS, SORD, SORK/MO Series, SORM

SAVE MONEY - ORDER BY THE CASE FOR 10% DISCOUNT

We have masking sheets available for: Didde Graphics, Halm, Harris, Imperial, Komori, Miehle-MGD, Omni-Adast, Rotaprint, Royal Zenith, Shinohara and Solna

CUTTING KNIVES/BLADES

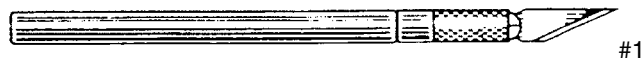

#1



#1-B

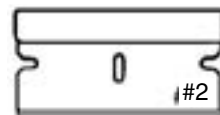

#2

#1	FG-3201	#11 Blade Handle	\$3.65
#1-B	LIT-XAC-611	#11 Blade 100/pk	\$33.25
#2	FG-5656	Single Edge 100/pk	\$7.60

PRINTERS PARTS STORE

800-543-1117 FAX: 800-392-4072
ORDER TODAY!!

SAVE COD FEES-WE ACCEPT
VISA*MASTER CARD* AMERICAN
EXPRESS and CHECKS-BY-FAX

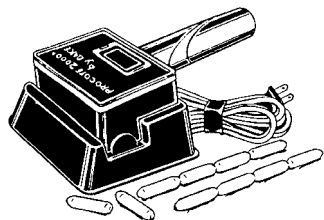

PROCOTE 2000® HANDWAXER

Rubber cement & spray adhesives are slow & messy. Paste ups with ordinary hand waxers are frustrating, lengthy warm ups, uneven wax coating, messy spilled wax.

Daige Procote 2000® eliminates all these problems because Procote 2000® is state-of-the art in hand waxing.

DA-2000	Handwaxer	\$75.00
DA-P10	Pro-Stick wax	\$4.95

RUBY RED LITHO TAPE

FG-9640	1/4" 4 rolls/box	\$19.80
FG-9641	3/8" 3 rolls/box	\$18.40
FG-9642	1/2" 2 rolls/box	\$16.20
FG-9643	3/4" 1 rolls/box	\$11.95
FG-9644	1" 1 rolls/box	\$15.40

MISC TAPE

FG-9530 white	1/2" 2 rolls/box	\$17.00
FG-9546 clear	3/8" 3 rolls/box	\$ 7.75

CORRECTION PENS & RULERS

IMAGE REMOVER PENS Allow you to remove images directly on plates and masters while they're on or off the press.

METAL PLATES:

MAR-2200 Fine Point \$6.65 ea
MAR-2201 Broad Point \$8.30 ea

ELECTROSTATIC PLATES:

MAR-3100 Fine Point \$95.40 dz
MAR-3101 Broad Point \$143.40 dz

SILVERMASTER PLATES:

MAR-4100 Fine Point \$10.65 ea
MAR-4101 Broad Point \$15.00 ea

NON-REPRO PENCILS

MAR-761 CLOSEOUT Pencil \$6.95 dz

IMAGE ADDITION PENS allow you to write directly on plates and masters while they're on or off the press.

METAL PLATES:

MAR-2100 Fine Point \$8.95 ea

ELECTROSTATIC PLATES:

MAR-3200 Fine Point \$7.50 ea

SILVER MASTER PLATES:

MAR-4200 Fine Point \$22.00 ea

FILM OPAQUE PENS:

MAR-150-2B-1 Black .10mm \$4.95 ea
MAR-150-2R-1 Red .10mm \$4.95 ea

GRAPHIC ARTS RULERS

BH-L612 available in 6" \$7.75, 12" \$8.00, 18" \$10.95, 24" \$13.25

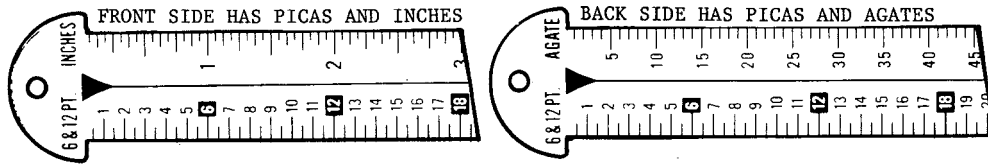

BH-L612-A
 available in 12"
 only \$8.00

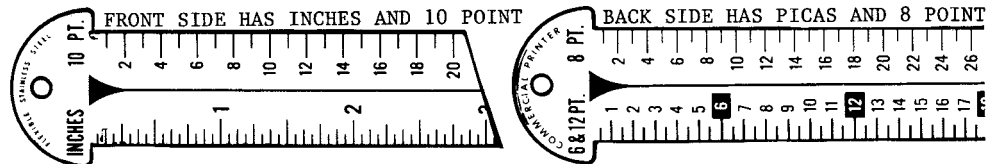

BH-L612-E
 available in 12"
 only \$8.00

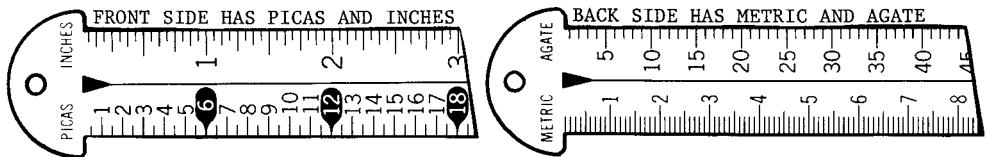

BH-L612-F
 available in 12"
 \$8.00, 18" \$10.95,
 24" \$13.25

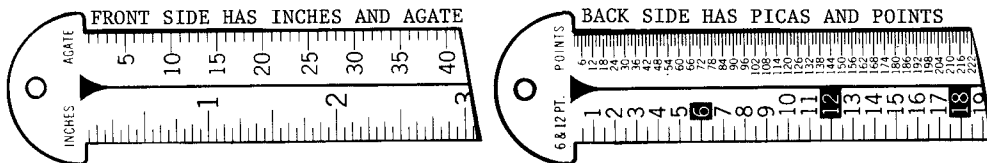

BH-L612-H
 available in 12"
 \$8.00, 18" \$10.95

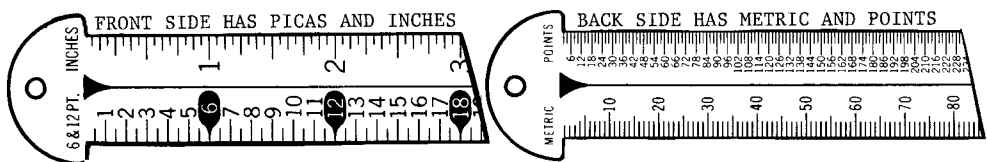

LOUPES, MAGNIFIERS, ALIGNMATES AND PROPORTION SCALES

FOLDING LINEN TESTER

with inside edges of base white filled graduation 1/8" apart.

BH-L726-AS	1/2" x 10X	\$11.95
BH-L734-DL	1" x 8X	\$16.95
BH-L730-A	1" x 7X	\$17.35

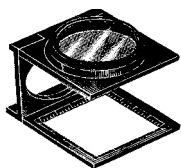

SWING BASE LINEN TESTER

BH-L723-G	12X	\$52.95
------------------	-----	---------



CIRCLE LOUPE

Features shadowless viewing, fixed focal length & achromatic

BH-909	1" x 10X	\$13.95
---------------	----------	---------

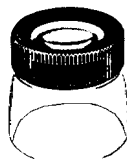

CUBE LOUPE Strong 8X lens with clear plastic base. Mount can be focused.

BH-L736	8X	\$ 7.45
----------------	----	---------

Other styles and sizes available

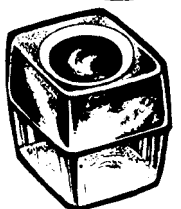

New Graphic Arts Type Gauge Rulers

Opaque rulers printed two sides include all the scales that you need for quick accurate type specifying. They feature precision cut slots to keep all point size scales flush to the edge for easy measuring. Durable plastic laminated construction.

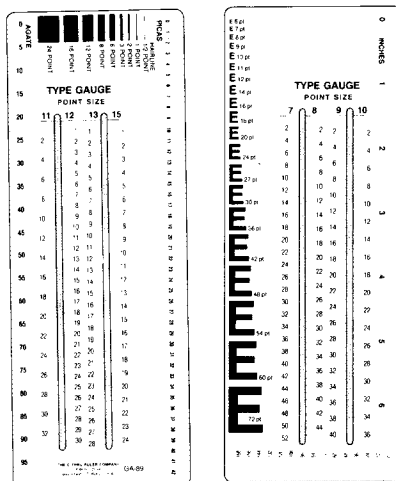

Scales include:

- Eight different point size type gauge
- Inch scale, Pica scale
- Agate scale, E Scale chart
- Printer's point size scale
- Ten line rules - Hairline to 24 point

Available in 2 great sizes:

BH-GA-88	(Standard size, 2 3/4"x12 3/8")	\$7.95
BH-GA-89	(Pocket size, 2 3/4"x7 3/8")	\$5.95

ALIGNMATE \$8.95

AlignMate®

8"x6" wide

straight (strät), *adj.*, undeviating, right, correct, in proper order or condition.

Use the AlignMate tool to check for straightness of text & graphics on paper sizes up to 11" x 14".

The edge of the printed material rests in the "C" fold which is precisely aligned with the 16 per inch grid.

AlignMate tools provide the precision of a T-square in a fraction of the time.

Cleanup is easy using soap & water or any standard blanket wash.

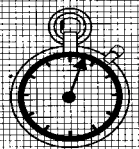

Save Time



Reduce Waste

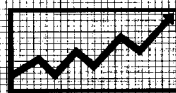

Increase Profits

AlignMate®

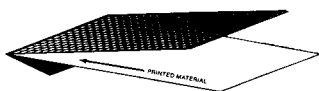

PROPORTION SCALES

Both proportion dials are designed to quickly ascertain new reproduction sizes for original art, copy or photos; give percentage of enlargement or reduction; show new size of any element or area of an original when the whole original is reproduced to a new size. Both have graduations in fractions under 1".

BH-LPS-80 8" \$8.00

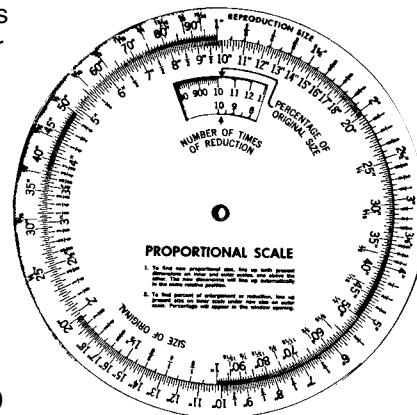

DELUXE DIAL

This dial is the same as above except it is 8-1/2" in diameter and has a clear cursor arm to "line up" graduations for easy reading.

BH-L657-A 8-1/2" \$12.00

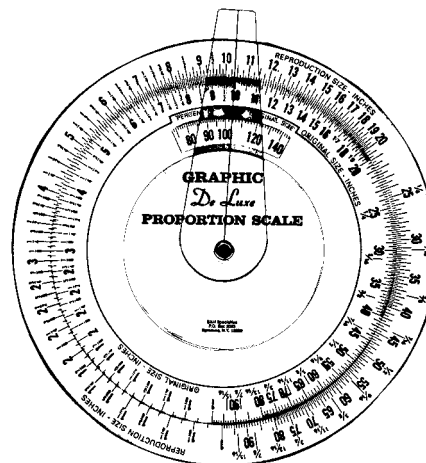

DIAL THICKNESS & BLANKET PACKING GAUGES, DUROMETER

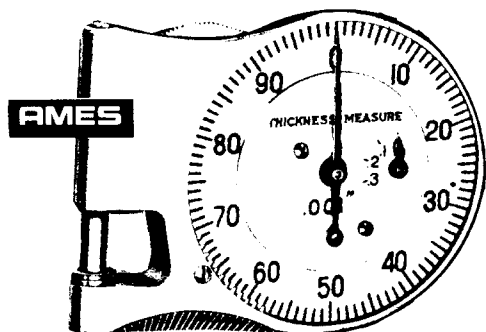

Graduated .001". Each graduation is equal to .001", each revolution of the pointer equals .100" Comes with case.

AMES			
BH-25	.001"		\$191.55
BH-251	.0005" graduation		\$202.90



Graduated .001" Pocket gauge weight is under 2 oz. Easy zero adjustment, measuring surface is hardened, ground & lapped. Comes with case.

FOWLER			
BH-52-545	.001"		\$133.95
BH-52-545-M	same as above except metric.		\$133.95

MICROMETERS



Features clear, easy to read numbers on the digital counter. As an added assurance of error free reading, every fifth thousandth is numbered on the thimble. The digit counter reads to .001", the sleeve reads to .0001".

FOWLER DIGITAL			
BH-52-222-001	Inch		\$138.20
BH-52-223-005	Metric		\$138.20



A practical and economical measuring device. Accuracy guaranteed to .001". Satin finish frames have friction thimble to permit consistent measurements. Hex wrench included for simple zero adjustments.

UTILITY MICROMETER			
BH-L102	Economy		\$29.95
BH-52-229-001	Fowler-Inch		\$45.00

TRUPAK BLANKET PACKING GAUGES



Use these gauges to measure packing of your blanket cylinders. Reduce dot gain, problems from overpacking, and wear on plates and cylinder bearings. Measures on press without damage to the blanket or plate.

Part#	Scale	Application	Price
LIT-EQP-TP	Inches	Sm Press w/Bearers	\$299.00
LIT-EQP-TPM	Metric	Sm Press w/Bearers	\$299.00
LIT-EQP-TPP	Inches	Med Press w/Bearers	\$549.00
LIT-EQP-TPPM	Metric	Med Press w/Bearers	\$549.00
LIT-EQP-TPF	Inches	Lg Press w/Wide Gutters	\$699.00
LIT-EQP-TPFM	Metric	Lg Press w/Wide Gutters	\$699.00
LIT-EQP-TPFA	Guard Jumper Arm Option		\$69.00

PLEXUS DUROMETER

A durometer is used to measure the hardness of "soft" surfaces such as printing rollers. Regular use of a durometer detects bad printing rollers before they cause print quality problems. Old rollers that have been used in alcohol dampening systems for extended periods of time may have become too hard to function properly. Use this simple, accurate device to determine if excessively hard rollers are causing your problems.



LIT-EQP-PLD	\$299.00
--------------------	----------

GraphLine

Plates and Chemistry

GRAPHLINE SMOOTH METAL PLATES: 2 SIDED, TRUE AQUEOUS HIGH RESOLUTION, SHAPER IMAGE AND DOT RESOLUTION, 25,000 IMPRESSIONS PER SIDE

PRESS MODEL	PLATE SIZE	ITEM NUMBER	QTY/BOX	PRICE \$
M1250	10X15 PB	GL-7300002	100	126.20
M1250	10X15-3/8 SL	GL-7300029	100	129.35
MULTI 1250LW/CHIEF 17	11X18 PB	GL-7300005	100	166.85
MULTI 1250LW/CHIEF 17	11X18 PB	GL-7300005-025	25	56.70
AB DICK 360	11X18-1/2 PB	GL-7300006	100	171.20
AB DICK 360	11X18-1/2 PB	GL-7300006-025	25	58.25
MULTI 1360/1650	12-3/4X18-1/16	GL-7300009	100	193.75
AB DICK 9800	13X19-3/8 PB	GL-7300012	100	211.90
AB DICK 9800	13X19-3/8 PB	GL-7300012-025	25	72.10
RYOBI 3302	13-3/16X19-3/32 SC	GL-7300013	100	243.60
MULTI 1850	15X18 PB	GL-7300014	100	226.70
DAVIDSON 700	16X17-1/2 SC	GL-7300019	100	235.55
2 IN 1 DEVELOPER	GALLON	GL-60-18107-001		36.75
NEGATIVE DEVELOPER	GALLON	GL-60-18107-002		34.25
GUM 100% PURE	QT	V-GUM ARABIC		10.80
UNIVERSAL PINK FOUNTAIN SOLUTION	GALLON	V-UNIVERSAL		14.30

Laser Direct™ - 50000 Series Laser Plates provide a high quality and affordable computer-to-plate solution to small and medium size press rooms. Ideal for short runs and spot color printing, Laser Direct plates are directly imaged using a high-resolution, dry tone laser printer (the HP LaserJet 5000/5100 series printer is ideal). Laser Direct plates do not require any additional processing. Simply wet the plate and run with specially formulated Laser Direct™ Universal Fountain Solution (diluted 32:1, water to solution). The plate's award winning technology offers enhanced surface conductivity and improved handling properties to provide fast turnaround and excellent quality. Laser Direct™ plates can be imaged on either side, can print in excess of 10,000 impressions, and hold screens of 120 LPI or better.

Size	Product Code	Price Per Pkg
8-5/8 x 12	BL-LASER-50000-100	\$62.06
8-5/8 X 14	BL-LASER-50005-100	\$72.40
8-5/8 X 15	BL-LASER-50007-100	\$77.57
10 X 15	BL-LASER-50010-100	\$89.94
10 X 15-1/24	BL-LASER-50015-100	\$92.94
11 X 18	BL-LASER-50020-100	\$118.75
11 X 18-1/2	BL-LASER-50025-100	\$122.05
11-1/8 X 18-1/2	BL-LASER-50021-100	\$123.41
11-1/4 X 18-1/2	BL-LASER-50022-100	\$124.79
12 X 18	BL-LASER-50030-100	\$129.55
12 X 19-3/8	BL-LASER-50031-100	\$139.40
12 X 19-7/8	BL-LASER-50034-100	\$143.00
13 X 19-3/8	BL-LASER-50035-100	\$151.05
13 X 19-7/8	BL-LASER-50036-100	\$154.95

Mitsubishi Silver Master Plate Material and Chemistry
SLM RIII PAPER PHOTO DIRECT PLATE 10,000 IMPRESSIONS
(2 ROLLS PER BOX - PRICES DO NOT INCLUDE FREIGHT)

PLATE SIZE	ITEM NUMBER	PRICE
10 x 246'	GL-60-17609-003	133.60
11 x 246'	GL-60-17609-004	146.15
11-1/4 x 246'	GL-60-17609-005	150.35
12 x 246'	GL-60-17609-006	160.15
SLM-AC ACTIVATOR 4x1GAL	GL-60-18608-002	H 89.23
SLM-AC ACTIVATOR 1GAL	GL-60-18608-002-1	H 22.50
SLM-ST STABILIZER 4x1GAL	GL-60-18609-003	79.61
SLM-ST STABILIZER 1GAL	GL-60-18609-003-1	19.95
SLM-OH-ETCH 1 QT	GL-60-18610-004	6.55
SLM-OA2 FOUNTAIN ADD 1LTR	GL-60-17889-001	16.45
SLM-OD FOUNTAIN SOL 1GAL	GL-60-18611-004	13.50
SDP ULTIMATE FOUNTAIN SOL 1G	GL-60-18611-008-1	38.25

H = HAZMAT CHARGES APPLY

Stop Plate Stretch with PLATESTRIPS For all paper, polyester and laser printing plates. Turn your disposable plates into metal plates. It's as easy as peel..press..punch...run
 GL-60-24014-001 25 pack \$16.95

Graphline General Purpose Camera Line & Halftone Film
 Dimensionally stable .004 polyester - Extremely High D-Max High Contrast
 Wide Developing Latitude - Rapid Access or Lith

SIZE	ITEM NUMBER	PRICE	PRODUCT	ITEM NUMBER	PRICE
10x12	GL-31-42047-202	74.20	A&B LITH CHEMISTRY 4x1GAL	GL-60-17649-005	107.80
11X14	GL-31-42048-202	95.22	R/A DEVELOPER/REPL 2.5 GAL	GL-60-17710-002	63.80
12x18	GL-31-42049-202	133.56	UNIVERSAL R/A FIXER 5GAL	GL-60-17710-013	61.60

Graphline Majestic Blue Proof Proofing Paper

Two sided monochrome proofing paper 4 mil thickness. The paper is exposed through a UV filter which is in contact with a film negative producing a visible dark blue image without the need of any chemical processing. (Compare to Dupont Dylux)

CLOSEOUT PRICES

GL-31-42352-102	12x18	\$65.00	GL-31-42354-102	16x20	\$80.00
-----------------	-------	---------	-----------------	-------	---------

Mitsubishi DigiPlate Products Now Available

Call us with material, size and specs

800-543-1117 / 201-935-9595

Fax 800-392-4072 / 201-935-5333

CHEMICALS: ROLLERS & BLANKET CARE, PLATE CLEANERS/CONDITIONERS, GUM

BURNSHINE® PRODUCTS

Roller and blankets cleaners that cut color change time by 50%.

PUTZ POMADE®

A must for deep cleaning of neglected rollers. Stops glazing and stripping; sharpens reproduction; rejuvenates and reconditions blankets and rollers.

- BP-Y1** 7 oz Bottle Liquid \$10.05
- BP-Y3** 13 oz Can Liquid \$15.10
- BP-R1** 15 oz. Can Paste \$10.70



CLEAR GEL™

A non-abrasive rollers and blankets cleaner that increases ink affinity to produce brighter colors and sharper reproductions, as well as a daily deglazer and conditioner. Ideal for quick color changes (even black to yellow). Prevents stripping and glazing. Extends roller life

- BP-Y9** 16 oz. Bottle Liquid \$13.15



PRINTERS PRIDE CHROME CLEANER and DESENSITIZER

This one step cleaner is one of the easiest and most reliable. Apply to chrome rollers, cylinders, anywhere you don't want ink to stick. Wipe on, and leave on. No scrubbing, no need to remove before printing. Will desensitize chrome, making it more Hydrophilic "Water-Loving" and Oleophobic "Ink-Hating"

- BP-3462Q1** qt. \$13.35



VARN® ORANGE-SCRUB HAND CLEANER

Citrus oil naturally and effectively breaks down and removes ink, dirt, grease and grime. Contains mild scrubbing beads, does not contain pumice.

- V-ORANGE-SCRUB.4** 4.5 lb. \$17.55

VARN® TRUE BLUE PLATE CLEANER/CONDITIONER

The original blue plate cleaner that has become the Industry standard. True Blue quickly and completely opens all types of metal plates, even after long periods of storage. Use to remove surface scratches, oxidation spots, semi-dried ink and gum streaks which reduce print quality. True Blue restores ink receptivity, just apply and rinse.

- V-TRUE BLUE** 1 qt. \$15.80

VARN® GUM ARABIC

100% Pure Gum arabic 14°Be. Flows to a smooth, thin, uniform film and offers maximum protection on plates and maximum performance in the fountain.

- V-GUM ARABIC** 1 qt. \$10.80

VARN® INK DRYING STIMULATOR

A water fountain additive to speed ink drying. Works with all acid based fountain solutions. Reduces smearing and set-off and greatly accelerates job turnaround.

- #V-IDS** 1 gal. \$49.00

VARN® COMPOUND 747

Makes good ink run better. Improves ink lay, reduces tack and makes it easier to control ink/water balance. prevents sheets from sticking to blankets and reduces picking.

- #V-747** 1 qt. \$10.95

VAN SON® RAPID 1STEP Glaze Remover

Prevents sticking, crystallization, offset and picking

- GL-GVS2028** 1 qt. \$ 9.95
- GL-GVS2029** 1 gal. \$32.95

VAN SON® SMOOTH LITH

Prevents sticking, crystallization, offset and picking

- GL-GVS2150** 1 qt. \$12.45

VAN SON® EAST STREET Roller Cleaner

Prevents sticking, crystallization, offset and picking

- GL-GVS2082** 10 oz. \$13.95

BURNSHINE® PLATE SAV-UR

America's leading cleaner and conditioner for metal plates. Removes scratches, scum, gum streaks and oxidation. Excellent re-starter for "standing" or pick-up" plates.

- BP-P2** 1 qt. \$11.90
- BP-P1** 1 gal. \$44.35

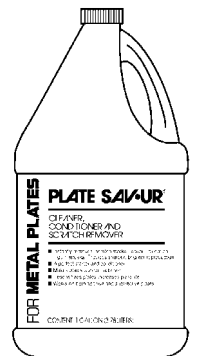

BURNSHINE® GOLD MIRACLE

Made expressly for photo-direct plates such as Onyx®, Megalith®, Silvertex®, Silvermaster® and all other silver based plates. This is a superb starter, cleaner, conditioner and scratch remover. It eliminates toning, scumming, scratches and paste-up marks as it gives longer, cleaner press runs.

- BP-L2** 1 pt. \$8.50



CHEMICALS: PRESS WASH AND FOUNTAIN SOLUTIONS

VARN® ROLLER AND BLANKET WASH

VWM Wash High performance at an economical price. Water miscible, removes both solvent soluble and water soluble glazes in one step.

V-VWM	1 gal.	\$18.40
V-VWM.5	5 gal.	\$87.00

PRONTO The original, deep-cleaning small press wash. Thorough glaze removal and low odor comfort.

V-PRONTO	1 gal.	\$18.40 H
V-PRONTO.5	5 gal.	\$83.75 H

H + HAZMAT CHARGES

CALIFORNIA WASH A non-photo-chemically reactive water miscible wash. Effective cleaner for all press sizes. Low aromatic content, low odor.

V-CALIFORNIA	1 gal.	\$20.05
V-CALIFORNIA.5	5 gal.	\$91.50

DUPLICATOR WASH A fast drying, deep-cleaning professional wash specifically engineered for small presses. Controlled evaporation rate, high flash point, mild odor. Ideal for inplant and quick print operations.

V-DUPLICATOR.5	5 gal.	\$99.50
-----------------------	--------	---------

BLUE RIBBON WASH Economy Wash 5gal \$54.50

V-120 WASH Water miscible blanket and roller wash. Contains hydro-flex which extends roller and blanket life. Will not rub rollers of their natural oils, keeping them in "like new" condition.

V-V-120	1 gal.	\$20.60
----------------	--------	---------

V-5GAL PUMP 5 gal. Pail Pump \$40.45

VARN® DEGLAZERS and REJUVENATORS are the key products in Varn's proven press maintenance systems, and are used in combination with a Varn water miscible wash.

VARN® TAKE-IT-OFF An innovative paste deglazer that removes ink and gum glazes. Contains mild, non-abrasive particulate. Leaves no residue. When used with a Varn water miscible wash, forms a roller maintenance system of the highest order.

V-TAKE-IT-OFF	1 lb. Tub	\$10.95
----------------------	-----------	---------

VARN® REVITOL A concentrated liquid detergent and rejuvenator to remove glaze and restores natural tack, revitalize and rejuvenate rollers and blankets. Very low VOC. Deep cleans to extend blanket and roller life.

V-REVITOL.1	1 gal.	\$23.05
--------------------	--------	---------

VARN® SUPER RUBBER REJUVENATOR Cleans and deglazes rubber fast, while restoring life and print ability to even the most glaze-blocked blankets and rollers. Leaves blankets and rollers velvety smooth and ink receptive, and adds thousands of quality impressions to blankets. This excellent rejuvenator will pay for itself many times over in increased productivity.

V-SUPER RUBBER

REJ.1	1 gal.	\$30.00
--------------	--------	---------

FOUNTAIN SOLUTIONS

VARN® TOTAL

A complete buffered fountain solution that requires no additives. Contains 100% pure gum. Engineered for all metal plates. When combined with PAR, will eliminate alcohol.

V-TOTAL	1 gal.	\$21.60
----------------	--------	---------

VARN® ELECTRO-STATIC A dual purpose product developed as a combination fountain solution to be used on press, and as a plate conditioner to be used in both conventional and pre-wetters. Starts clean and stays clean.

V-ELECTRO-STATIC	1 gal.	\$21.45
-------------------------	--------	---------

VARN® UNIVERSAL PINK All plate, small press fountain solution. Formulated for small presses equipped with conventional, integrated or Kompac Automatic Dampening systems. Excellent results on metal, camera or photo direct plates and all inks. Alcohol & glycerin free.

V-UNIVERSAL	1 gal.	\$14.30
--------------------	--------	---------

VARN SUPER-LENE All purpose small press fountain solution compatible with all plates and effective with all types of ink. Glycerin based, no ph or conductivity convert. Mix to performance.

V-SUPER-LENE	1 gal.	\$22.65
---------------------	--------	---------

ISOPROPYL ALCOHOL

V-IPA	1 gal.	\$17.65 H
V-IPA.5	5 gal.	\$57.00 H

H + HAZMAT CHARGES

VARN® PAR A unique alternative to IPA and alcohol replacement. Replaces isopropyl alcohol. PAR provides wider latitude to your fountain solution and helps to form a stable water-in-ink emulsion without altering the body of the ink.

V-PAR.1	1 gal.	\$36.05
----------------	--------	---------

MITSUBISHI SILVER MASTER Fountain Concentrate.

GL-60-18611-004	1 gal.	\$13.50
------------------------	--------	---------

PAPER CUTTERS and SUPPLIES

PAPER CUTTING STICKS

Plastic cutting sticks available for:

- MBM/Ideal Triumph 9/16" sq.
- Challenge 1/2" sq.
- Michael 5/8" sq.
- Chandler & Price 1/2" sq.
- Imperial 25/32" x 5/16



Other sizes available.

Please call with cutter make, model # and cutting stick size.

CALL for pricing.

BOOK TRIMMING GUIDE CLAMPS

Cut books quickly and safely.

Clamps safely hold down the folded or stitched side of the booklet while being trimmed in the cutter.

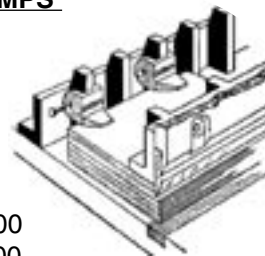

RU-46 For Challenge \$38.00

RU-47 For Ideal/Triumph \$28.00

PAPER CUTTER KNIVES

High quality inlaid carbon alloy steel. Available for MBM Ideal Triumph, Challenge, Chandler & Price, Seybold, Michael Miracle & more. Please call with make, model # and knife size. CALL for pricing.

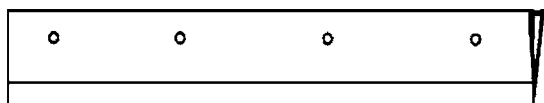

JOGGER AID Jogger Block

keeps hands from blade while jogging paper against the back gauge.

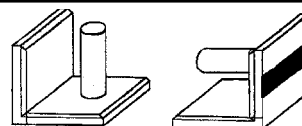

- JJB38** 3"x8" Long \$32.00
- JJB312** 3"x12" Long \$48.00
- JJB412** 4"x12" Long \$52.00
- JJB512** 5"x12" Long \$57.00
- JJB612** 6"x12" Long \$65.00
- JJB618** 6"x18" Long \$98.00

TRIUMPH PAPER CUTTERS

is the leading name in precision paper cutters for the quick print, copy shop, in-plant and offset printing markets. Select from a full range of cutters - from manual, to automatic, to fully programmable and hydraulic.

Model 3095 & 3915 shown with optional stand, makes efficient use of your work-space.

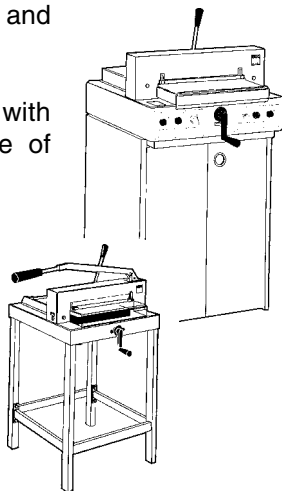

TRIUMPH 3905 AND 4700 MANUAL CUTTERS

These all purpose cutters are so compact, you can place them almost anywhere.

Next to:

- *Copy/duplicating machines
- *Word Processors
- *Desktop Publishing Systems

They offer the precision and durability of our larger Triumphs, with enhanced safety features. Model 3915 is the only tabletop electric paper cutter on the market.

TABLETOP CUTTER SPECIFICATIONS

	3905	4700	3915 semi-automatic
Cutting width:	15-3/8"	18-3/4"	15-3/8"
Cutting height:	1-1/2"	3"	1-1/2"
Narrow cut:	1-1/3"	1"	1-3/8"
Cut length behind knife:	15-3/5"	19"	15-3/5"
Table length in front of knife:	6-2/5"	8-2/5"	8"
Ship weight:	95 lbs	294 lbs	162 lbs
Wt. with stand	121 lbs	320 lbs	188 lbs
Price	\$1379	\$2499	\$3499

MAGNETIC CUTTER PADS

Protects paper stock, carbon, NCR from damaging clamp pressure. Magnetic pads stick to clamp.

P-30995 3" x 15" \$32.00



TRIUMPH 4810 SEMI-AUTOMATIC AND 4850/6550 FULLY AUTOMATIC CUTTERS

These affordable 18" & 25-1/2" cutters with stands offer precision and operating simplicity as well as the greatest possible safety. The safety package includes front and rear guards, true two hand operation, safety key to lock blade and disk brake for instant blade stop. Model 6550 cuts 25-1/2" paper, allowing print shops to buy parent stock to reduce costs.



SPECIFICATIONS:

	4800	4850	6550
Cutting width:	18-3/4"	18-1/2"	25-1/2"
Cutting height:	3"	3"	3"
Narrow cut:	1-1/4"	1-1/4"	1-3/8"
Cut length behind knife:	19"	19"	24"
Table length in front of knife:	13-3/5"	13-3/5"	16-1/5"
Ship Wt with stand:	457 lbs	511 lbs	739 lbs
Price	\$5499	\$7249	\$8199

*These Items shipped F.O.B. Point of Origin

PADDING PRESSES AND PADDING SUPPLIES

The ECONO PAD

Pads up to 8,000 sheets 8-1/2" wide. Carousel base rotates 360°. Clamping system allows for adjustable pressure. Extra padding board sets are available for higher production levels. Shipping weight 30 lbs.

GP-ECONO-PAD \$199.00

Padding Press

GP-ECONO-PAD-X \$99.00

Extra padding unit.



LASSCO MULTI-PUNCH FOR LIGHTWEIGHT METAL, PLASTIC AND CARD STOCK

Designed to provide multi-punching capabilities through a variety of interchangeable punching dies. Configuration include corner rounding, notching, scalloping, 1/8" hole, and strap slot. Available sizes and shapes: NOTCHING - Provided in 4 sizes, 1/8" to 1/2". Each punch has the capability of notching only or notching with a hole. CORNER ROUNDING - The corner rounding dies are also available in 4 standard sizes from 1/8" to 1/2". SCALLOPING - Available in 4 sizes, 1/8" to 1/2". Deeper scallops can be produced by moving the adjustment.



LAS-MP-10 \$395.00 Dies From \$155.00

PAD ABOUT

This versatile unit maximizes shop space and pad production. The Pad About pads up to 10,000 11" wide sheets. Convenient rotating table eliminates the need to lift paper stacks. Stand allows for moving padding unit to where the job is or moving it out of the way when not in use. Constructed of 3/4" select white maple with welded steel frame. Shipping weight 110 lbs.



GP-PAD-ABOUT

\$525.00

ADJUSTABLE PAD COUNTER

Adjusts up to 4". Set tongue depth to desired thickness and insert into pad. A real time saver. Measure equal amounts everytime.



W-172 \$12.00

QUICKIE PAD COUNTER

Makes five pads at one time. Shortens production time. Count a ream at a time.

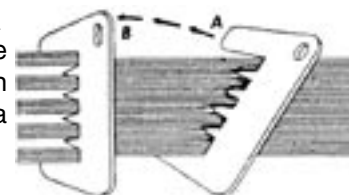

W-173 \$5.00

PAD SEPARATING KNIFE

Specially made for cutting pads. Carbon steel blade holds sharpness longer. **W-174** \$10.35



PARTNER

PADDING PRESS

With Swival Base

- Instant pressure release!
- Pads up to 18" wide, 22" h
- Swival base allows 360 de
- Requires only a minimum
- Sturdy wood construction.
- Cast iron clamps...
to last a lifetime!

High Capacity

W-175

Partner Padding Press
\$300.00

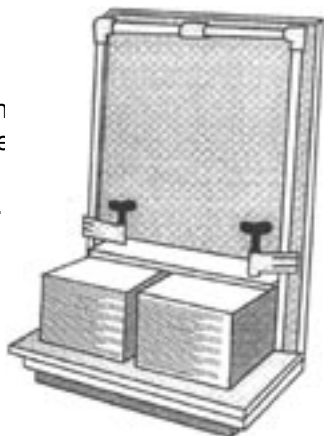

PADDING BRUSH

2" wide. Made of soft white bristle that tapers to a flagged point. **FG-42702** \$3.95



HAR ADHESIVES

PADDING COMPOUND

HAM-HPCWQ White / Quart \$7.50
HAM-HPCWG White / Gallon \$20.45

FAN APART for use with NCR® Brand PAPER

HAM-HNCRQ qt. \$11.60
HAM-HNCRG gal. \$27.75

*These items shipped F.O.B. Point of Origin

LASSCO Joggers

Table Top Jogger

Perfect for quick printers and mail rooms. Jogs a full ream of standard copy paper. Ideal for checks and envelopes also. Table size: 4"W x 13" H
LJ-2 \$595.00



Table Top Jogger

Large table allows for perfect alignment of all forms of paper products. Table size: 15 1/2"W x 15 1/2" H (The table is interchangeable with the LJ-6 table)
LJ-4 \$895.00



Table Top Jogger

Four bins for faster sorting and collating of paper, envelopes, checks and other materials. 4" wide bins. Table size: 18 1/2"W x 10" H (The table is interchangeable with the LJ-4 table)
LJ-6 \$895.00



Sprint 5000 Bookletmaker

This highly productive Sprint is the industry's most popular bookletmaker, capable of on-line corner, side and saddle stapling to produce a variety of professional looking reports, manuals, presentations and magazines.

- Corner, side and saddle stapling on-line
- 5 stapling positions including 1 for true corner stapling.
- 5000 staple cartridge makes reloading infrequent for increased efficiency.
- Auto stop and signal light when out of staples
- Bypass to skip fold rollers for side or corner stapling
- On-line bookletmaking option with Maxxum 6 and 10 bin models or other popular vertical collators.

PRICE: SPRINT 5000 \$6,599.00
SPRINT 3000 \$5,699.00

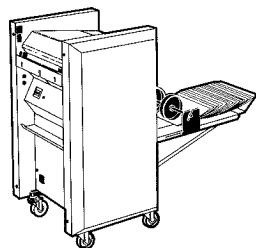

PRINTERS AIR PURIFIER

Cleans 1000 square feet. Removes press powder, odors, chemical fumes, smoke, dust, pollen and paper dust. Two speeds. Full 360° filtration, washable dust filter, low maintenance.

P-30020 Purifier \$495.00
CI-JC115-005 6 lb. Charcoal \$45.00
CI-JC105-012 Dust Filter \$45.50



MBM SIMPLIMATIC FOLDER

The Simplimatic is the perfect affordable choice for churches, clubs, schools, and home offices. No mechanical setup - just dial in the fold you want.. Manual feed of up to three sheets stapled or auto feed of single sheets. Exclusive snap-put cartridge is virtually maintenance free. Auto-static strip for high-static environments, carbonless paper.

PRICE: \$999.00

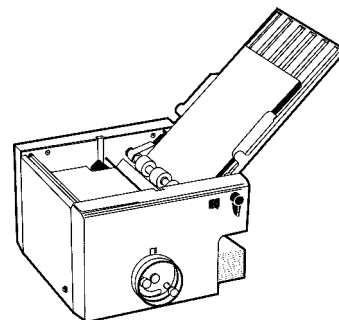

MBM FAST FOLD 352

Known for superior ease of operation, the 352S (shown) accurately folds more than 22,000 sheets per hour. Adjusts in seconds for eight standard and non-standard folds. Sheet separation by friction from top of fanned stock. Superior multi-roller feeding system handles a wide variety of paper, including carbonless.

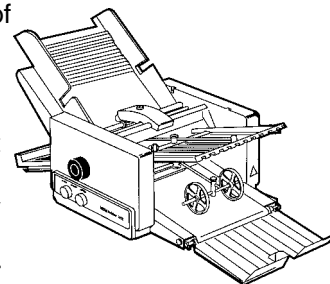

SPECIFICATIONS: MODEL 352F

Max. speed: 22,000 sheets/hr
 Paper size: 2: x 2-3/4" to 14" x 21-1/4"
 Paper weight: 13 to 110 lb.
 Electrical: 115 V, 60 Hz
 Ship weight: 105 lbs.

PRICE: \$4199.00

All Items Shipped F.O.B. Point of Origin

Prices subject to change without notice

PAPER DRILLS AND SUPPLIES

REGULAR and TEFLON® COATED HOLLOW DRILL BITS

Certified hardened tool steel full length, not just the tip, to resist bending and wobble.
All Drill Bits Shown Are Actual Size

2 1/2"
Length
1/4" & 5/16"
Style A for
3 & 5 Spindle



1/8"
3mm



3/16"
4.76mm



1/4"
6.35mm



5/16"
8mm



3/8"
9.5mm



1/2"
12.7mm



Style A
use on
3 & 5
SPINDLE
for
Challenge:
EH3A
MS5
MS10
Sky Lab
440



2 1/2"
Capacity

Style A
for
Challenge
Lassco-Spinnit
Super Speed
Casco-Climax
Ottawa-Rosback
Mark III-Mark IV
2" Capacity
on 1/4", 5/16",
3/8" & 1/2"
3/4" Capacity
on 1/8"
1 1/4" Capacity
on 3/16"



1 1/4"
Capacity

Style L
for
Lassco-
Spinnit



1"
Capacity

Style J
for
Martin Yale
101
Super
Speed
101
Lihit Drill



3/4"
Capacity

Style K
for
Martin
Yale
202
Lihit
2"
Capacity



NEW!!!

Regular Drill Bits:

Part#	Size	Style	
W-195-AA	3/16	A	\$26.00
W-195-AB	1/4	A	\$26.00
W-195-AC	5/16	A	\$26.00
W-195-AD	3/8	A	\$26.00
W-195-AE	1/8	A	\$26.00
W-195-AF	1/2	A	\$26.00
W-168-H	1/8	J	\$26.00
W-168-J	1/4	J	\$26.00
W-168-K	3/16	L	\$23.00
W-168-L	1/4	L	\$23.00
W-168-M	5/16	L	\$23.00
W-168-N	3/8	L	\$23.00
W-195-AR	1/4 A 2.5"		\$30.00
W-195-AS	5/16 A 2.5"		\$30.00

Add a -T to the end of the part# for Teflon® coated drill bits. Call for pricing.

PRECISION SHARPENER

21 blade cutting head. Style A & L bits fit perfectly in holder. **W-169-A** \$135.00

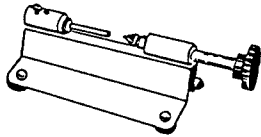

PENCLTYPE SHARPENER

16 blade cutting head. **W169-B** \$89.00

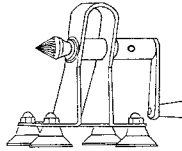

HAND SHARPENER

8 blade cutting head. Easy to use. **W-169-C** \$59.00

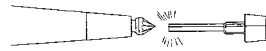

DRILL-EASE

Paper Drilling Lubricant
Reduces friction & heat on hollow paper drills. Just apply on cutting edge. **W-171-3** \$4.00 ea



***SPINNIT® SINGLE and 3 SPINDLE FLOOR MODEL**

PAPER DRILLS *

Come in 1" and 2" drilling capacity and feature traversing tables, hands free operation and low maintenance.

FM-1-R 1" single spindle \$1,545.00

FM-2 2" single spindle \$1,995.00

FMM-1-R 1" three spindle moveable heads \$3,495.00

FMM-3 2" three spindle moveable heads \$4,235.00

FMMP-3 2" three spindle moveable heads pneumatic powered drill \$4,935.00



***SPINNIT® SINGLE SPINDLE BENCH MODEL ***

A rugged compact drill that provides high production at low cost. Equipped with 2" drilling capacity and traversing table for easy multi-hole drilling. **EBM-2** \$1,045.00
EBM-5 w/E-Z Glide table \$1425.00

Also available by SPINNIT® is the **EBM-1R** (not shown), a lightweight table top paper drill designed and priced economically for most office, school, library and small print shop applications. 1" drilling capacity with quiet direct drive operation. **EBM-1R** \$740.00



DRILL BLOCKS

P-30811 1-1/2" X 3/4" \$2.25

P-30812 3" X 3/4" \$3.50

Items Shipped F.O.B. Point of Origin

STAPLERS / PERF & SCORING

SALCO® R106 ELECTRONIC FLAT / SADDLE STAPLER

Gives users an incredible amount of flexibility in stapling applications. Simply by adding extra units and fiber optic cables, users can go from single to multiple head stapling in less than 10 minutes. The R106 is capable of stapling from 2 to 45 sheets. Dual adjustable touch strips enable exact staple placement. 4" throat depth. Uses 1/4" and 5/16" staples.

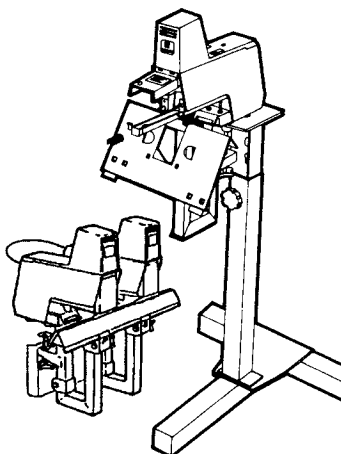

R106 Stapler -single head	\$435.00
R106-G1 *Gangster Package - 2 heads	\$1020.60
210/6EBS 1/4" Staples	\$5.70
210/8EBS 5/16" Staples	\$6.70
80-J Optional adjustable stand	\$150.00

REPLACEMENT STAPLING HEADS

Available for:

Rapid 101 W-101-301	\$70.00
Rapid 106 SALCO-R2EL/106	\$51.50
*MBM Sprint Bookletmaker W-110	\$85.00



*also fits O & M System 60, but does not have "out of staples" indicator lamp

SCORE II - SCORING & PERF MACHINE

Perforate and score with one machine. Interchangeable perf and score wheels. 8 perfs per inch. Easily adjustable edge guide. Full width guide insures accuracy on 1 or 1000 sheets (for best results, do one sheet at a time). Handles stock from 20 lb to heavy cover stock. Hand operated. Precision tooled assembly with solid construction and a 1 year warranty. 1 score and 1 perf wheel included.

W-630	Max perf length 19 1/2"	\$325.00
W-635	Max perf length 25"	\$375.00

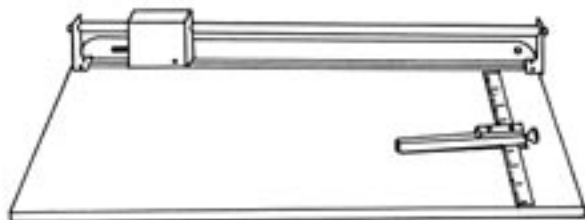

SKREBBA HEAVY DUTY FLAT / SADDLE STAPLER

Binds up to 50 sheets. Great for 11 x 17 center stapling. Uses 5/16" and 1/2" staples (5/16" up to 25 sheets, 1/2" up to 50 sheets). Two adjustable paper guides for accurate positioning of brochures, catalogs, etc. Manual power lever action. Easy bench mount.

W-115 Heavy Duty
Flat/Saddle Stapler \$175.00

Staples:

W-118-A 5/16" 23/8	\$4.00
W-118-B 1/2" 23/12	\$4.50
W-118-C 11/16" 23/17	\$6.00
W-118-D 1/4" 23/6	\$4.00
W-118-E 3/8" 23/10	\$4.50



18" PERFORATING & SCORING MACHINE

By **COUNT MACHINERY COMPANY**

Affordable • Effortless • Reliable

PerfMaster

Achieve short to mid volume Perforating & Scoring with ease.

FEATURES:

- Desk top space saver model
- 19" wide feed capacity
- Self-fanning automatic bottom friction feed
- Set-up and operation is a breeze
- Perf/Score/Slit Depth control setting
- Quickly change from perforating to scoring
- Simple to use one button operation speed control
- Mount up to maximum of (4) Perf or Score assemblies
- Micro-lateral adjustments for easy set-up of perforating & scoring
- Feeds single sheets, coated stock or multi-part open or glued edges
- Speed: Up to 26,000 sheets per hour
- Sheet size: 4" x 4" to 19" x 22"
- Weight: - Net: 66 lbs. - Gross: 85 lbs.
- Overall dimensions: 43" L x 27" W x 18"
- Electrical: Standard 110v 50/60 Hz. Also avail: 220v 50/60 Hz
- Warranty: 5 year on mechanical (except on wearing parts) & 1 year on electrical

Equipped standard with: (1) each perforating & scoring assemblies

Perforating blade styles available:

MicroPerf • 5-1: (18 teeth) • 9-1 (33 teeth) • 12-1: (45 teeth)

Visit our website for more Count Products:

<http://www.ppsnj.com/lasco/count.html>

STITCHING WIRE

BS-24G5	24 Gauge	5 lb	\$12.00
BS-25G5	25 Gauge	5 lb	\$12.00

We carry the complete line of Deluxe Stitcher Heads & replacement parts.

POWDER SPRAY UNITS AND POWDER

AIRTECH® SPRAYERS are manufactured for a wide variety of presses including ABDick, Arrow, Chief, Davidson, Embassy, Multigraphics, Hamada, Heidelberg, Itek, Ryobi and Toko. There is a model to suit every printer's need. Please call for Pricing.

<p align="center">EZ SPRAY™</p> <p>Budget Conscious Sprayers</p> <ul style="list-style-type: none"> *Easy installation *Self contained with compressor *Adjustable powder concentration *Anti-static spray bar design <p align="center">\$535.00</p>	<p align="center">PowderMite™</p> <p>Economical Powder Sprayers</p> <ul style="list-style-type: none"> *Impression triggered compressor shut-off *Adjustable powder concentration **"Test" mode for setting spray powder concentration *Anti-static spray bar design <p align="center">\$930.00</p>	<p align="center">MizerPlus™</p> <p>Mid Range Powder System</p> <ul style="list-style-type: none"> *Length of spray control *Auto speed sensing for press speed changes *Adjustable powder concentration **"Test" mode for setting spray powder concentration *Anti-static spray bar design <p align="center">Starting at \$1,165.00</p>	<p align="center">PowdAir3™</p> <p>Premium Quality Spray System</p> <ul style="list-style-type: none"> *Air blowdown for improved sheet delivery * Length of spray control * Auto speed sensing for press speed changes * Impression triggered compressor shut-off * Adjustable powder concentration * "Test" mode for setting spray powder concentration * Anti-static spray bar design <p align="center">Starting at \$1,375.00</p>
--	---	---	--

ORTMAN MCCAIN CO. (O.M.C.) SPRAYERS Sprayers are available for ABDick, Chief, Gestetner, Davidson, Hamada, Heidelberg, Multilith, Itek, Ryobi, Omni-Adast, Rotaprint and Royal Zenith. The OMC Powder Spray Systems have a NEW powder pick-up system, calibrated powder dial, improved control, large spray powder supply and are easy to operate. Please call 800-543-1117 for more information and pricing. Prices Starting At \$330.00

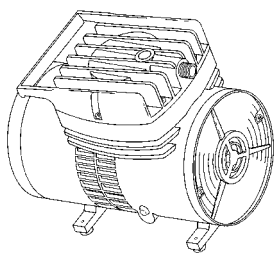
<p>VARN SPRAY POWDER 23 Micron</p> <p>V-RSP.11 R23 Spray Powder 11 lb box \$29.85</p> <p>V-RSP.55 R23 Spray Powder 55 lb box \$87.61</p>	<p align="center">HIGH PERFORMANCE</p> <p>A no maintenance, low noise diaphragm compressor designed for Airtech powder spray systems provides high performance and reliability over the life of the machine.</p>  <p align="center">COMPRESSOR AT-AA-18T \$220.00</p>
<p>AIRTECH SPRAY POWDER 25 Micron</p> <p>AT-25MICRON-5BX Spray Powder 5 lb box \$29.00</p> <p>packed in individual 5 oz. packets</p>	

WIZER POWDER SPRAY GUNS FOR ABDICK, RYOBI, MULTI, CHIEF

Extremely easy to use!
Takes seconds, just slide powder stops over sprays and put powder exactly where you want it.

- Ink more heavily without offset
- Prevent offset regardless of humidity
- Air shut off valve for on / off action
- Save powder...keep press and press area clean
- Comes complete with air timing valve that permits spraying only as the sheet passes, and no spraying between the sheets
- Runs off press pump
- No holes to drill (on most presses)
- Designed for quick and easy installation
- Powder stops make powder control precise

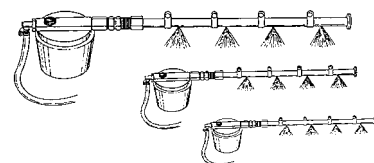

W-121-A	ABDick 350, 360 Chute	\$175.00
W-121-B	ABDick 350, 360 Chain	\$175.00
W-121-C	Multi 1250, 1250LW Chute	\$175.00
W-121-D	Multi 1250, 1250LW Chain	\$175.00
W-121-E	Chief 15, 17 Chute or Chain	\$175.00
W-121-F	Ryobi 2800, 3200 / Itek 960, 975	\$230.00
W-122	Universal for Larger Presses	\$200.00
W-123	ABDick 385 and MGD	\$200.00
W-123-A	ABDick 375, 9800 Chain	\$195.00
W-123-B	Multi 1360 Chain	\$195.00
W-123-C	Multi 1650 Chain	\$195.00

ORDER TODAY NO MINIMUM ORDER PHONE: 800-543-1117 FAX: 800-392-4072

SPINKS INK / INK SCALES / CORNER ROUNDERS

SPINKS INK The small press specialists offers a variety of inks to suit your needs:



ACRYLIC The most versatile ink for your press. Our unique Acrylic formulation delivers non-skinning qualities of a rubber base with the gloss and drying qualities of an oil base ink. From coated to uncoated stock, solids coverage to fine screens, metal to paper plates, our Acrylic formula provides for trouble-free printing day in and day out.



QUICKSET OIL BASE A premium work-n-turn oil base ink. This fast drying world class ink offers optimum gloss in a smooth running, low tack formulation. Quickset is available in all Pantone® colors as well as four color process. Quickset inks are also compatible with the current generation of laser imprinting equipment provided they are given 48-72 hours to dry prior to imprinting.



PERMABIND inks are formulated for non-porous stocks or hard to dry surfaces. It is also recommended to resist the heat of older laser copiers that generate extreme temperatures, i.e. IBM3800. Various applications of this product may require technical advise. Spinks has a full range of ink reducers, driers, overprint and binding varnishes available.

OHAUS TRIPLE BEAM SCALE

- SP-5002** grams 1.35 lb capacity \$155.00
- SP-5003** gram wt set for mixing over 1.5 lb \$20.00 closeout price
- LIT-EQP-OH86000** 1 lb capacity parts \$229.00
- SP-5006** part weight set 1.5 lb. \$35.00

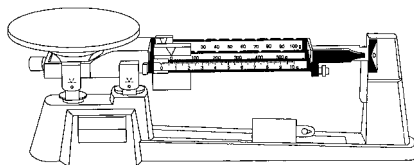

INK KNIFE

High quality carbon steel blade. Easy to clean. 1-1/2" wide, 4" long

- FG-9004**
\$18.35

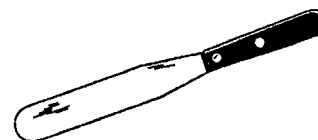

OHAUS DIGITAL SCALES

- SP-S5001-400** Ohaus Scout 0.88 lb. \$195.00
- SP-S5001-600** Ohaus Scout 1.32 lb. \$295.00

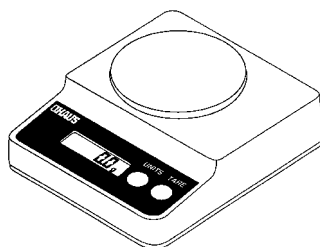

VAN SON SMOOTH LITH

Anti-set-off and smooth lay compound prevents crystallization, sticking, offset & picking.

- GL-GVS2150** Quart \$12.45

VAN SON 1STEP GLAZE REMOVER

- GL-GVS2028** Quart \$ 9.95
- GL-GVS2028** Gallon \$32.95

NICE-n-EZ CORNER ROUNDER

The only "trouble free" corner rounder in the world. Precise and smooth cutting actions produces clean uniform results. Cuts up to 1" of 8-1/2" x 11" stock. 5-1/2" grip and longer handle for comfort and more leverage. Heavy dut metal construction, built for long life.

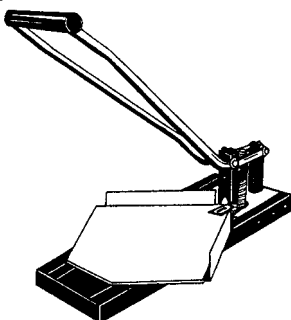

- W-177-1** 1/4" and 3/8" blade/die \$395.00
- W-177-2** 1/8" and 1/2" blade/die \$395.00

Purchase includes 2 blades and 1 cutting die.

Additional blades and dies may be purchased separately.

LASSCO CORNERROUNDS®

Desktop Heavy Duty Model CR 50B

Cornerround® designed with smooth rigid cutting action for hard-to-do jobs. Accepts full range of interchangeable cutting units (1/16" to 1 1/2" radii) One standard cutting unit (1/8", 1/4", 3/8", or 1/2") included.

- LAS-CR-50B** \$290.00 Table Top Model
- LAS-CR-50** \$685.00 Floor Model

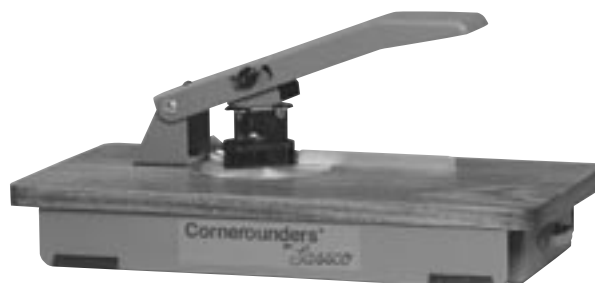

NUMBER-RITE AND NUMBER-ALL features:

- 6 wheel numbering head
- Number from 1-999,999
- Sinkable zeros: forward action
- Repeat numbering: electrically operated by foot pedal

NUMBER-RITE ELECTRIC NUMBERING MACHINE

Easily goes through 8-part NCR. Sharp clean numbers; adjustable hit crash number through 8-part carbonless; moveable paper guides for simple registration. Head can be tilted forward or backward to make sure you get the best impression. Number consecutive, duplicate, triplicate, 4X, 6X, 12X or repeat. Change from Gothic to Roman in seconds. Purchase includes 1 Gothic Head w/ink pad clip, 1 bottle of ink and 3 ink pads.

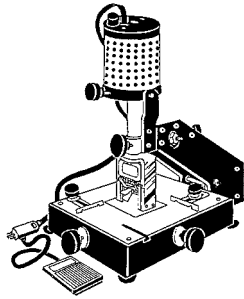

- | | |
|-------------------------------------|------------------------------------|
| W-100-3 Number-Rite \$995.00 | W-100-G Strike Pad \$ 5.50 |
| W-100-A Gothic Head \$155.00 | W-100-B Roman Head \$155.00 |
| W-100-C Black Ink \$ 5.50 | W-100-D Red Ink \$ 5.50 |

Numbering Supply Kit all the supplies you need in one kit:

1 dozen ink pads, 3 bottles of ink (black, red, blue), 2 ink pad clips, 1 plastic stylus (to set numbers), 2 green strike pads to replace worn pads.

- | | |
|--------------------------------|---------|
| W-100-H for NUMBER-Rite | \$49.00 |
| W-200-H for NUMBER-ALL | \$49.00 |

ENVELOPE BACKSTOPS

for ABDick and Multilith Durable all metal construction. No installation needed, just unclamp the regular backstop and install the Wizer Backstop in its' place and run envelopes at top speed without misfeeds.

- | | |
|--|---|
| W-125 for AB Dick
350,360,375,9800 | W-126 for Multilith also
fits Hamada 500,
600, 700 |
|--|---|

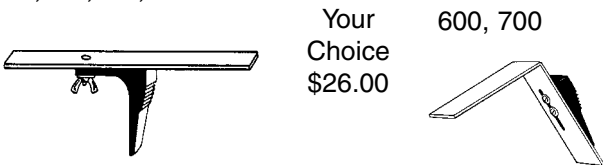

Your
Choice
\$26.00

NUMBER-ALL ELECTRIC NUMBERING MACHINE

Goes through 4-part NCR Great for small jobs. Sharp clean numbers. Number tickets, booklets, NCR, etc. Simple registration by moveable paper guides. Consecutive, duplicate, triplicate, 4X, 6X, 12X or repeat action. Purchase includes 1 Gothic Head with ink pad clip, 1 bottle of ink and 3 ink pads.

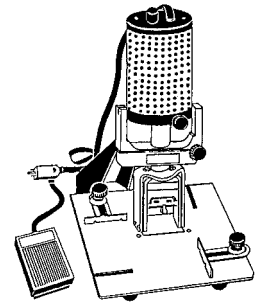

- | | | |
|----------------|------------|----------|
| W-200 | Number-All | \$885.00 |
| W-200-A | GothicHead | \$155.00 |
| W-200-G | StrikePad | \$5.50 |

PUNCHMASTER

Punches any size plate. Put your paper, polyester and metal plates on the plate cylinder straight every time. No need to stop the press and straighten the plate.

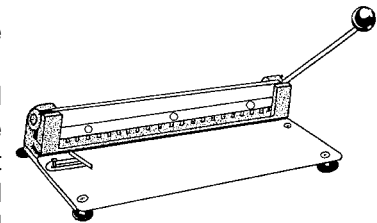

The Punchmaster uses pins made of E-52100 hi-carbon steel, heat treated to tool steel hardness. Has adjustment for any width plate up to 12" wide, with open ended adjustable plate guide. Punch 25 holes 11/64" diameter, spaced 1/2" center to center, 3/16" from top.

- | | |
|----------------|----------|
| P-30001 | \$379.00 |
|----------------|----------|

BUSINESS CARD SLITTERS

MODEL 412 TABLETOP
For Business Cards
4, 10 and 12 up

- | | | |
|------------------|-----------|-------|
| MY-BCS104 | \$1006.33 | 4 Up |
| MY-BCS210 | \$1338.57 | 10 Up |
| MY-BCS212 | \$1338.57 | 12 Up |

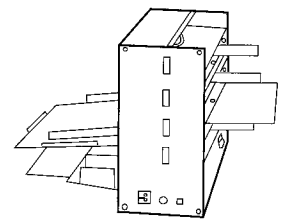

ATRATEx™ BUSINESS CARD SLITTER

Cut, Perf, Score. Cuts 500 cards in less than 3 minutes. Two models available: 12 up format to meet your business printing needs (will also do 4 up), and 10 up for laser printing. Use for business cards, invitations, raffle tickets, etc.. Simple adjustments and set-up for quick and easy cutting. Automatic rubber rollers feed card stock through the cutters (maximum 50 sheets 65# stock). Will not mark your card stock as with shear type cutters. Flat double-edge blades, durable, reversible and safe! Compact size will fit on your desktop. 8-1/2 x 11" may be cut to 1/2 or 1/4 sheets, or special sizes from 1-13/16 min. to 7-3/8 max.

- | | | |
|------------------|--------------------------|---|
| MY-BCS410 | 10 up slitter \$1,827.14 | - for 10 up laser printed cards w/ perf & score |
| MY-BCS412 | 12 up slitter \$1,827.14 | - for 12 up laser printed cards w/ perf & score |

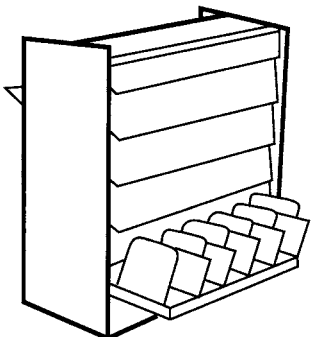

GRAPHLINE PRISM DIGITAL DUPLICATOR SUPPLIES / COPIER TONER

Risograph® (Riso) Model #	Ink	Part # (min. order 2 cartridges)	Masters	Part # (min. order 2 rolls)
RC4000, 4500, 5600 5800 RA4200, 4900, 5900	Black 1000cc Blue (process) 1000cc Red (warm) 1000cc Green 1000cc Bright red 1000cc Brown 1000cc Federal Blue 1000cc Teal 1000cc Reflex Blue 1000cc	GL-INKRARCBLK \$21.20 GL-INKGRBLUE \$30.60 GL-INKGRGREEN \$30.60 GL-INKGRBRED \$30.60 GL-INKGRBBWN \$30.60 GL-INKGRFED \$30.60 GL-INKGRTEAL \$30.60 GL-INKGRRFXBLUE \$30.60	RA/RC (A4) 227mm x 100m	GL-MARARCA4 \$25.00 \$25.00 Closeout Price While supplies last
RC6300	Same as above	Same as above	RC (A3) 320 mm x 103m	GL-MARCA3 \$60.70
GR1700, 1750, 2750	Black 1000cc cart	GL-INKGRBLK \$21.20	GR(A4) 227 mm x 100m	GL-MAGRA4 \$41.50
GR3750	Same as above	Same as above	GR (A3) 320 mm x 103m	GL-MAGRA3 \$61.30
GR 3770	Black 1000cc cart	GL-INKGRHDBLK \$30.60	GR (A3) 320 mm x 103m	GL-MAGRA3600\$71.30
RP/FR	Black 1000cc	GL-INKRPBLK \$21.20	A3	GL-MARPA3 \$61.30
TR/CR	Black 800cc cart	GL-INKTRBLK \$18.70		GL-MATRA4 \$40.60
System Model #	Ink	Part # (min. order 2 cartridges)	Masters	Part # (min. order 2 rolls)
Ricoh®/Standard® VT1730, 1800, 2130 Gestetner® 5303, 5304 5315; Savin® 3100DNP; ABDick® 6120, 6130	Black 600cc/cart Red 600cc/cart Blue 600cc/cart Green 600cc/cart N/A for ABDick	GL-INKVTSS \$12.40 GLINKVTSSRED \$17.30 GLINKVTSSBLU \$17.30 GLINKVTSSGRN \$17.30	VT (A4) 240 mm x 125m	GL-MAVTA4 \$49.50
Ricoh®/Standard® VT2105, 2200, 2300 Gestetner® 5325, 5327, 5330, 5360; Savin® 3200CP; ABDick® 6520, 6530, 6550	Same as above N/A for ABDick	Same as above	VT (B4) 280 mm x 125m	GL-MAVTB4 \$53.90
Ricoh®/Standard VT3500, 3600, 3800 Gestetner® 5375, 5380 5385; Savin® DSD-3000 3300DNP; ABDick® 6720 6770, 6790	500cc & 600cc same as above Black 1000cc cart N/A for AB Dick	600cc same as above GL-INKVT \$20.80	VT (A3) 320 mm x 125m	GL-MAVTA3 \$66.30

IN STOCK - NO MINIMUM ORDER! OTHER MODELS AVAILABLE

Press Specialties C-9000 UNIVERSAL ENVELOPE FEEDER

Completely Universal
For All Presses Using Conventional Suckers!

Envelope Feeder For:

AB Dick • Hamada

Heidelberg • Itek

Ryobi • Toko

*All other presses with
conventional suckers.

Features...

No stopping to reload.
Continuous loading of stock
from the top, bottom vacuum
fed, one at a time. Increases
production and continual print-
ing. Micr adjusting jogger for
side to side registration. Run
perfect registration on busi-
ness cards & envelopes on your
direct-drive presses! Cranks up
& down for any press height.



Independent
Vacuum System

C-9000 installed on a RYOBİ 3302
Move from Press to Press within minutes!
AVAILABLE WITH OPTIONAL CONVEYOR

**ENVELOPES 3" X 5" TO 10" X 13" RUN WITH EASE - FROM COIN THROUGH
STANDARD, FULL FLAP REMITTANCE, PHOTO MAILERS, BOOKLET AND
CATALOG ENVELOPES; FOLDED STOCK, CARTONS & CARD STOCK RUN
TROUBLE FREE. ALL OTHER PS ENV FEEDERS & PARTS ALSO AVAILBLE
OTHER FEEDER MODELS AVAILABLE AS WELL AS PARTS**

PRESS
SPECIALTIES MFG
INC.
ENVELOPE FEEDERS

AUTHORIZED DEALER

PRINTERS PARTS STORE
82 HERMAN ST E. RUTHERFORD, NJ 07073
800-543-1117 / 201-935-9595
Fax 800-392-4072 / 201-935-5333

Suspension Feeder

Envelope Feeder

Compatible with all small parts to medium landscape / portrait format printing presses regardless of feeding systems (Stream Feeder / Sheet Feeder)



Envelope Feeder



Delivery Conveyor

**MADE
IN
THE
USA**

- No electrical or mechanical connection to the press is needed. Timing and speed automatically match the press.
- Feeds envelopes continuously
- From start to finish, the stock remains FLAT.
- Virtually maintenance free
- Every part is warranted for 8 years
- Feeds all common envelopes, including catalog and booklets. 3 1/2"x5 1/2" up to 10"x13"
- Includes a three foot free standing delivery conveyor*

Standard Features

- Fiber Optic Sensing
- Dial In Length Setting
- Hydraulic Height Setting
- Delivery Conveyor
- Locking Wheels
- Adjusting Scales
- Jogging Shelf
- Warranted 8 Years

***Options**

- Five Foot Variable Speed Delivery Conveyor

For Stream / Sheet Fed Presses

- Continuously prints envelopes. Timing and speed automatically match the press. No need to stop and reload press feeder every few hundred envelopes.
- Continuous feeding maintains quality and reduces waste.
- Installs quickly without electrical or mechanical connection to the press.
- Automatically adjusts itself to all printing speeds.
- Designed for run lengths of 1000 and above.
- Feeds most business size envelopes from 3 1/2x5 1/2 up to 10x13
- A delivery conveyor provides efficient unloading and reboxing of envelopes.
- All parts on both envelope feeder and delivery conveyor are warranted for 8 years.
- Spare requirements: Approximately 4' in front and behind press.

Specifications:

Stock Size: Minimum: 3 1/2" x 5 1/2" • Maximum: 10" x 13"
Power: 60 hz, 110 volt, 1 amp

FULLY PATENTED

TOWNSEND MAKES IT HAPPEN

T-51



A.B. DICK 350 AND 360® SWING-AWAY® T-51

Min/Max Sheet Size*	3"x5" to 11 ³ / ₂ " x 17"
Running Speed*	2,500 IPH to 9,000 IPH
Plate Size*	10" x 15", 11" x 15" or 11" x 18 ¹ / ₂ "
Maximum Image Area	10 ¹ / ₂ " x 13" or 10 ¹ / ₂ " x 16 ¹ / ₂ "
Weight	164 lb. Net, 214 lb. Shipping
Floor Space Requirement	Swing Position 2.2 sq. ft. Print Position NONE

*Determined by or the same as Parent Press

A.B. DICK 375® SWING-AWAY® T-51

Min/Max Sheet Size*	3"x5" to 11 ¹ / ₂ " x 17"
Running Speed*	2,500 IPH to 9,000 IPH
Plate Size*	13" x 18 ¹ / ₂ "
Maximum Image Area	12 ¹ / ₂ " x 16 ¹ / ₂ "
Weight	175 lb. Net, 225 lb. Shipping
Floor Space Requirement	Swing Position 2.2 sq. ft. Print Position NONE

*Determined by or the same as Parent Press

MULTI® 1250 and 1250 LW Swing-Away® T-51®

Min/Max Sheet Size*	3"x5" to 11" x 17"
Running Speed*	5,000 IPH to 10,000 IPH
Plate Size*	10" x 15" PB, 10" x 15 ³ / ₈ " SL, 11" x 15" PB or 11" 18" PB
Maximum Image Area	12 ¹ / ₂ " x 16 ¹ / ₂ "
Weight	181 lb. Net, 231 lb. Shipping
Floor Space Requirement	Swing Position 2.1 sq. ft. Print Position NONE

*Determined by or the same as Parent Press

Swing-Away and T-51 are registered Trademarks of Townsend Industries, Inc.
MULTI is a registered trademark of AM International, Inc.
Stationary heads are also available.

T-51 Heads available for all AB Dick, Multith, Chief, Ryobi and Toko Press Models.

Swing-Away and T-51 are registered Trademarks of Townsend Industries, Inc.
Stationary heads are also available.

Two-color printing has never had it so good...so precise...so quick...so easy, and Townsend made it all happen! The Townsend Swing-Away™ T-51® is especially designed to give you engineering advantages unavailable before and yet still offers the same Quality - Reliability - Productivity expected in T-51 performance.

Designed for operational ease and convenience

The T-51 is equipped with a single lever control with controls the ink, water and print positions in one easy move of the control lever.

Removing the T-51 and returning it precisely back into place is simple and easy thanks to the T-51 Swing-Away. The T-51 Swing-Away is equipped with a rotating arm which allows the entire unit to be either swung away from the duplicator or back into its normal operating position in about one minute. The T-51 Swing-Away allows unrestricted access when running single color work. It also increases the ease of serviceability of both units.

Performance Inking and Moisture Systems

Illustrated is the T-51 fourteen roller ink/moisture system. Designed for quality printing, the system features different diameter form rollers and oscillators that significantly control ink recovery and coverage.

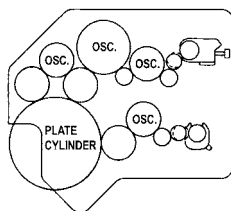

The T-51 moisture system is supplied with a molleton system or the unique Townsend "Aqua-Flow" system. The "Aqua-Flow" system is a segregated dampening unit which allows the form, oscillator, transfer, and ductor rolls to carry both ink and water. This provides a tree form roll system. Two forms carry only ink while one carries both ink and water. Both the molleton and "Aqua-Flow" systems offer equal T-51 quality and performance.

An infinite moisture control and water ductor lock-out are featured on the T-51. The water fountain roller can be set to rotate at an infinite number of settings to allow a finer control of moisture distribution to the plate. For clean-up or when the T-51 is idling, the water ductor can be locked out. Both features offer the ultimate in T-51 moisture control.

Register

The T-51 has ultra sensitive adjustments for easy plate alignment. A micro adjustment allows the plate to be twisted without removing it from the cylinder. A micro horizontal adjustment and micro vertical adjustment provide precise dot-for-dot register between the two colors. These are all valuable time-savers in setting up two-color work.

Increased Production and Profits

Precise register between the two colors is guaranteed on every sheet you print. And not only will you double your two-color production, but washup, waste and storage will be sharply reduced or eliminated. This means hundreds of dollars to you each month. Putting the Townsend T-51 to work for you today will be one of the most profitable decisions you will ever make. Ask your Townsend dealer for a demonstration

STOP TRACKING!

SiliCLEAN™ ANTI-MARKING SURFACE PROVIDES FREEDOM FROM INK TRACKING



NO-MARK®

We've been using "No-Mark" SiliCLEAN on our Speedmaster102 for over 2 years and it's performance and ease of installation has exceeded our expectations. An excellent product that really works!"
 Bill Knowles Univel Press

- Transfer and Delivery Cylinders.
- No Messy Adhesives or Tapes Needed.
- Replaces Blue Nets.
- Impression Cylinders on Perfecting Units.
- All Stocks and Weights, Including Foils/Plastics.
- Longest Life of any Replaceable Surface.
- SMOOTH-No Lint-Picking on Wipedown.
- Precision Cut Sheets or Rolls.
- It's Repositionable! For Fast, Easy Install

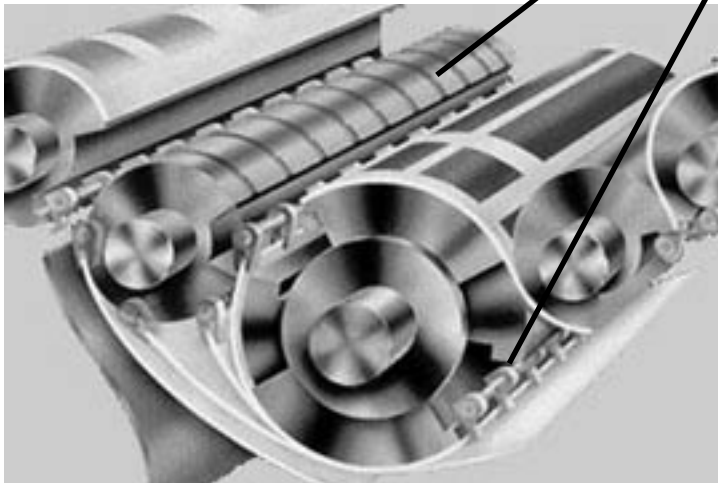
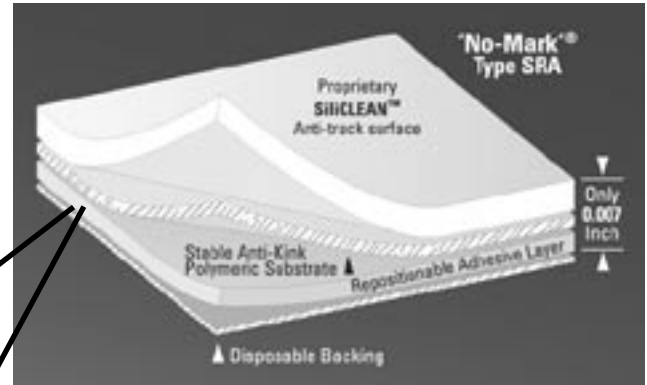

HEIDELBERG SPEEDMASTER 72/74	\$ 77.00
HEIDELBERG SPEEDMASTER 102	141.00
KOMORI 26"	70.00
KOMORI 28"	75.00
KOMORI 32"	99.00
MIEHLE 36"	103.00
MIEHLE 38"	120.00
MILLER TP-104	162.00
MILLER TP-38	131.00
MITSUBISHI 28"	69.00
MITSUBISHI 408"	139.00
OMNI-ADAST 20"	37.00
OMNI-ADAST 28"	70.00
SOLNA 125/225/425	55.00

PRICE LIST

FOR POPULAR PRESS SIZES

Price is per sheet. SiliCLEAN is sold 2 sheets per package.

PRESSES UP TO 13"X18"	\$ 31.00
AKIYAMA 28"	69.00
AKIYAMA 32"	95.00
AKIYAMA 40"	137.00
HARRIS 29"	89.00
HARRIS 38"	139.00
HEIDELBERG GTO-46	31.00
HEIDELBERG GTO-52	40.00
HEIDELBERG MO	66.00
HEIDELBERG SORD	125.00
HEIDELBERG SORM	78.00
HEIDELBERG SPEEDMASTER 52	45.00

MORE OPTIONS

"No-Mark" SiliCLEAN is made for any press size. If your press is not listed call us toll-free at 800-543-1117 for pricing. Also available with plain back (no adhesive) and in roll form. Catalog prices subject to change.

NO-MARK®

YOUR SOLUTION PROVIDER FOR DIFFICULT PRINTING APPLICATIONS

STOP TRACKING!

THE MOST ECONOMICAL & EFFECTIVE ANTI-MARKING FOR ALL YOUR PRESSES



\$250 "No-Mark" Master Craftsman Package

Includes 2 Main Wheels, 16 TEFCLEAN Feet and 12 "Tuff Work" Bush Wheels. Print HEAVY SOLIDS, HALFTONES & SCREENS with no flaws. Soft thin face natural hair brush wheels repel ink and provide the famous "No-Mark" Floating Kiss™ to all text weight coated papers.

Price listed above valid for most duplicator size presses including basic sets listed below:

AB DICK 360/375/9800; ATF-CHIEF 15/17; HAMADA 500/600/800; MULTI 1250/1650/1850; RYOBI 2800/3200



\$290 "No-Mark" Premier Craftsman Package

Includes 2 Main Wheels, 16 TEFCLEAN Feet, 12 Heavy Stock TEFCLEAN wheels and 12 "Tuff Work" Brush Wheels. The addition of TEFCLEAN Wheels in the Premier package gives you the ability to run up to 28 point coated board stocks with ease. Well worth having on hand.

Price listed above valid for most duplicator size presses including basic sets listed below:

AB DICK 360/375/9800; ATF-CHIEF 15/17; HAMADA 500/600/800; MULTI 1250/1650/1850; RYOBI 2800/3200



\$435 "No-Mark" Supreme SiliCLEAN Full Cylinder Anti-Tracking

Includes 2 Main Wheels, 16 TEFCLEAN Feet, anti-track Blanket holding components and one SiliCLEAN Anti-Tracking Blanket. This is for press operators that demand top-of-the-line hassle-free performance. SiliCLEAN outperforms loose net systems. Access to back cylinder is easy, and you can run any type and weight of stock with no adjustments or make-ready at the delivery end. Simple to use and truly Supreme!

Price listed above valid for most duplicator size presses including basic sets listed below:

AB DICK 360/375/9800; ATF-CHIEF 15/17; HAMADA 500/600/800; MULTI 1250/1650/1850; RYOBI 2800/3200

No-Mark Basic Set starts @ \$195.00 includes 2 main wheels & 16 Tefclean Feet available for presses listed above. Also made for any press.

Printers Parts Store
82 Herman Street
East Rutherford, NJ 07073

PRESORTED
STANDARD
US POSTAGE PAID
RUTHERFORD, NJ
PERMIT NO. 348

Attn: Press Maintenance Supervisor